

The background of the slide is a technical drawing or blueprint, rendered in a light orange color against a darker orange background. It features various geometric shapes, lines, and symbols, including circles, rectangles, and what appears to be a gear or a complex mechanical part on the right side. The drawing is somewhat faded and serves as a decorative backdrop for the text.

UMass AGC Student Chapter

Chapter Meeting

March 29, 2021

Today's Agenda

- Introductions
- Announcement from Prof. Civjan
- Officer Elections
- AutoCAD Activity

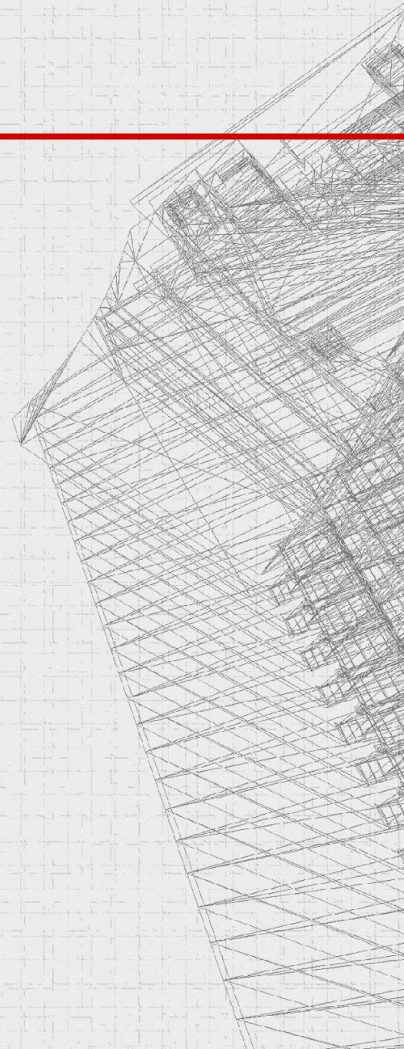

Events for the Rest of the Semester

April 19

BIM and CM of the Physical Sciences Building (Jeff Veilleux of Whiting-Turner)

End of April

Environmental Impacts of Construction (Tim Dexter of MassDOT)

Informal Meeting?

Officer Elections

- We encourage you to run for a position!
- All current positions up for re-election
- Read officer roles on next page
- Nate will record names for all positions
- Candidates give a short speech about why they're running
- Vote

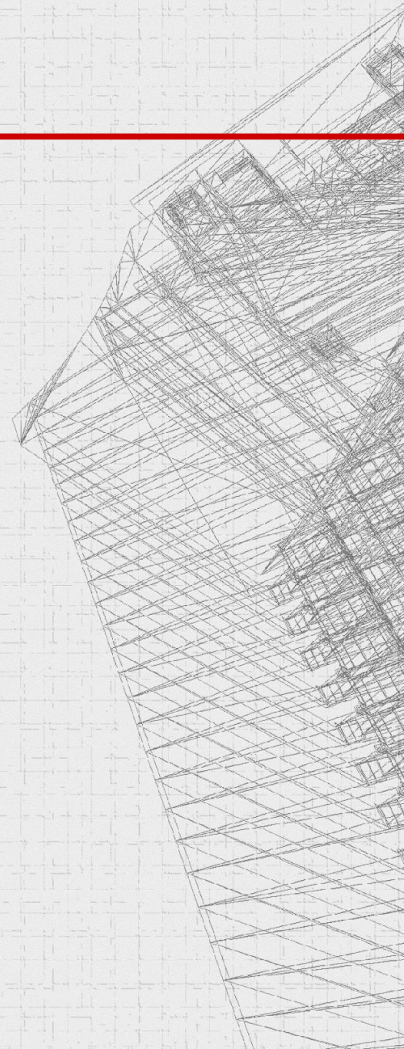

Officer Elections

President

Primary leadership and direction of the club

Actively seeks networking and community involvement opportunities for the club

Leading and scheduling of officer meetings

Professional correspondence with industry professionals and faculty

Organize club events and plan agendas

Vice President

Assist President with leadership responsibilities

Periodically check-in on task progress made by other officers.

Keep track of information in officer meetings

Organize club events and plan agendas

Professional email correspondence with faculty and industry professionals

Secretary

Correspondence with BCT students and faculty

Update and manage the AGC Facebook page

Assist with professional email correspondence

Manage documents in AGC google drive

Record attendance and take meeting notes

Treasurer

Oversight of club finances

Correspondence with engineering faculty to manage club funds

Provide resources to club members

Organizing catering and event finances

Creates a formal budget for the club to follow

Keeping track of all financial transactions

Club Representative

Collaborating with other clubs (such as ASCE) on events (JSES representative)

Draft emails to the general body

Answer emails send to AGC Email

Assist with professional email correspondence with faculty and industry professionals

Seek out resources for general body

Outreach

Design and maintenance of club website

Create flyers with event information and sign up links

Recruitment of new and prospective members

Update the bulletin board

Officer Elections

President
Primary leadership and direction of the club
Actively seeks networking and community involvement opportunities for the club
Leading and scheduling of officer meetings
Professional correspondence with industry professionals and faculty
Organize club events and plan

Vice President
Assist President with leadership responsibilities
Periodically check-in on task progress made by other officers.
Keep track of information in officer meetings
Organize club events and plan agendas
Professional email correspondence with

Secretary
Correspondence with BCT students and faculty
Update and manage the AGC Facebook page
Assist with professional email correspondence
Manage documents in AGC google drive
Attendance and take meeting

All Positions: flexible roles; may help plan events, provide input, and attend officer meetings (usually biweekly)

Treasurer
Oversight of club finances
Correspondence with engineering faculty to manage club funds
Provide resources to club members
Organizing catering and event finances
Creates a formal budget for the club to follow
Keeping track of all financial transactions

Outreach
Collaborating with other clubs (such as ASCE) on events (JSES representative)
Draft emails to the general body
Answer emails send to AGC Email
Assist with professional email correspondence with faculty and industry professionals
Seek out resources for general body

Outreach
Design and maintenance of club website
Create flyers with event information and sign up links
Recruitment of new and prospective members
Update the bulletin board

Voting

- Google Forms
- Anonymous
- Can only vote once

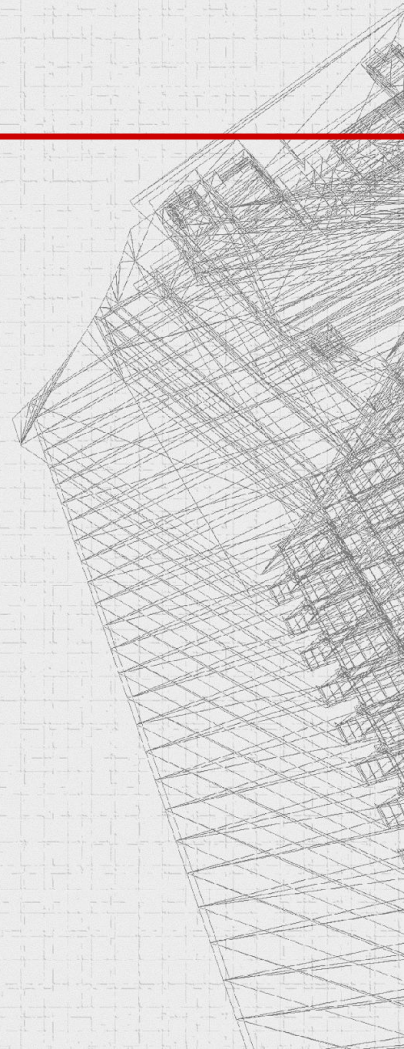

Other Announcements

- AGC Discord: <https://discord.gg/AcQamWt9>
- Blog Posts
- AGC Scholarship: <http://www.agcmass.org/scholarships>
 - Application Deadline: June 1

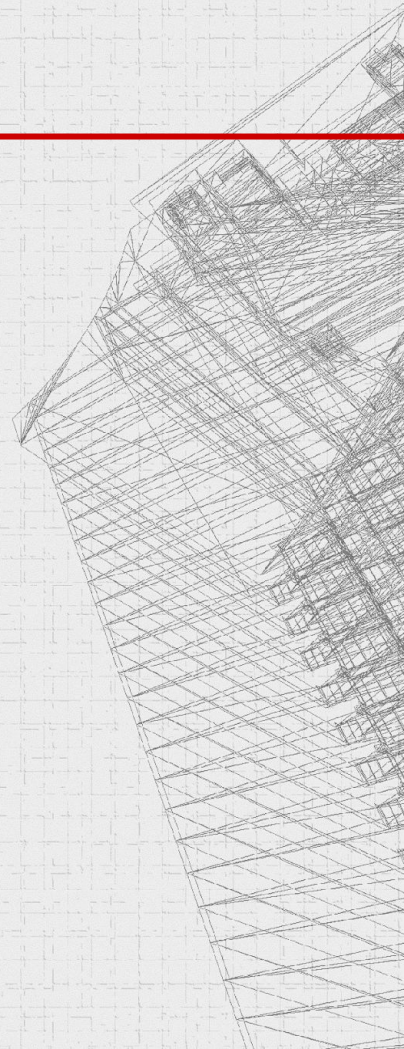

AutoCAD Exercises

- 2D Image provided
- Recreate in AutoCAD
- Goal 100% accuracy
- Prize:

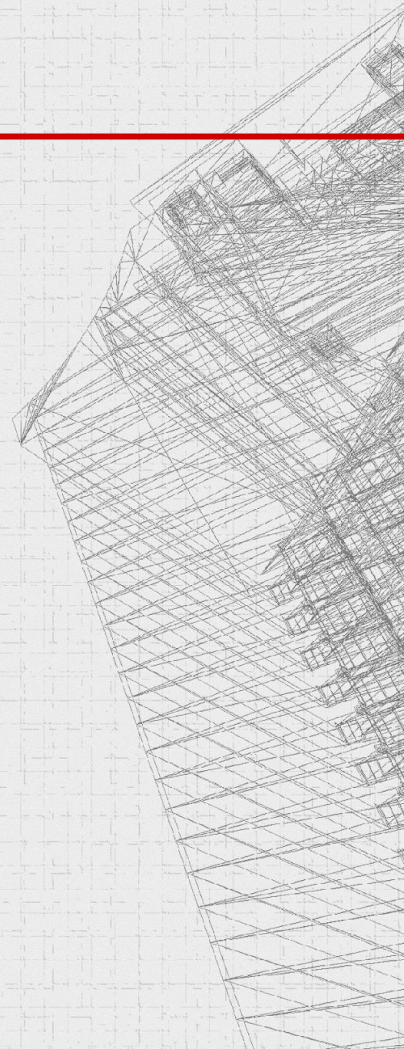

AutoCAD Exercises

- 2D Image provided
- Recreate in AutoCAD
- Goal 100% accuracy
- Prize: Kevin will do any dare you want him to
Just kidding, we have hard hat sticks and AGC hats

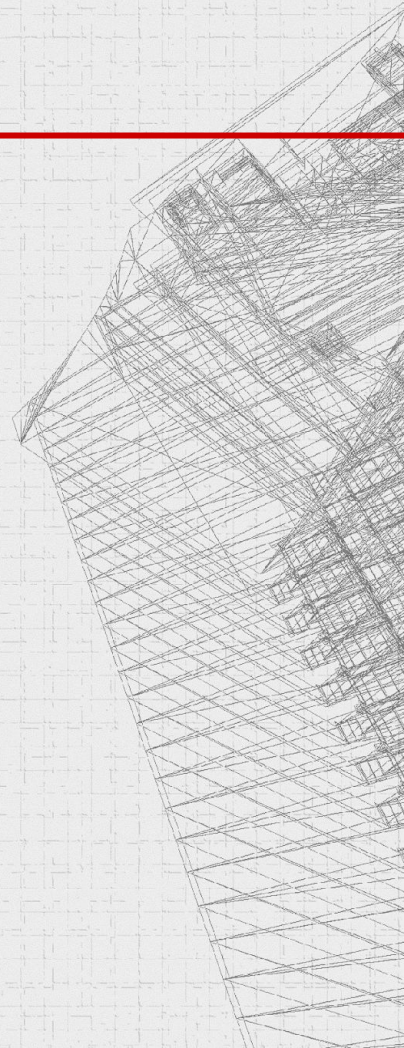

AutoCAD Exercise

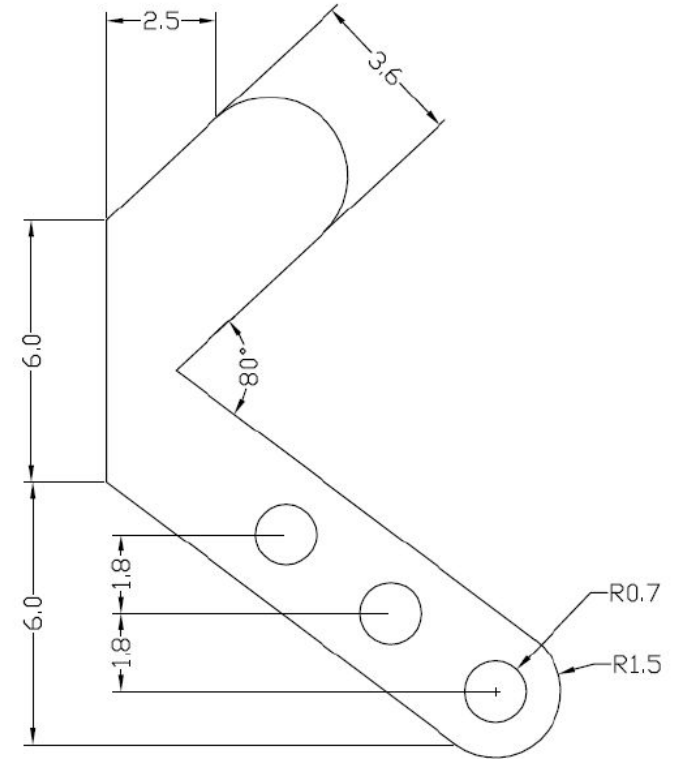
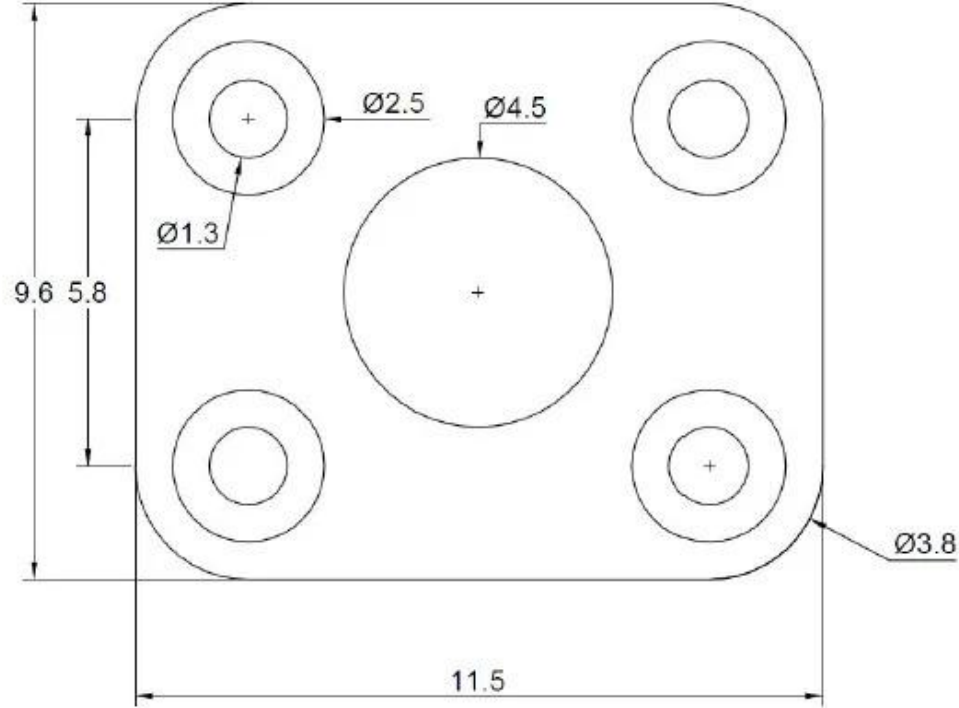

AutoCAD Exercise

