

Desktop / Floor-Standing Vacuum Forming Machines



⋮ **508DT/FS**



Installation, Operating and Service Manual

For Parts, Service & Technical Assistance

Telephone: +44 (0) 1582 469 797



Fax: +44 (0) 1582 469 646

Safety	4
Introduction	8
General Arrangement 508DT	9
Machine footprint	9
Electrical Specifications	10
Mechanical Specifications	10
Transportation / Positioning	10
Noise emissions	10
Machine storage	10
General Arrangement 508FS	11
Machine footprint	11
Mechanical Specifications	12
Transportation / Positioning	12
Noise emissions	12
Machine storage	12
Electrical Specifications	12
General Arrangement 508DT & 508FS	13
Installation and Initial assembly 508	16
Lifting and Handling - 508DT only	16
Heater Guard - 508DT & 508FS	17
Fitting reducing windows (optional)	18
Air Outlet connection - 508DT only	19
Installation and Initial assembly (508FS only)	20
Counterweights	20
Castor option	21
Fitting the Castors	21
Fitting the rear stabilisers	22
Cooling fan option	23
Compressed air connection - 508FS only	25
Operating Procedures - Quick start guide	26
Introduction to the 508 control system - Operating buttons and icons	26
Initial Requirements (508DT & 508FS)	28
Main Menu	29
508DT Basic operation	30
508DT Settings	31
508DT Saving Parameters to Memory	32
508DT Operating using saved parameters	32
508FS Basic Operation	33
Operating Procedures - Other settings / loading programs	35
508FS Fan system activation	35

Optional extras	36
Tools	37
508DT/FS standard baseboard	38
508DT/FS reducing window baseboard	39
Plastics	40
Post Forming Operations	41
After forming	41
Trimming	41
Warranty	42
Seals	42
Heating elements	42
Vacuum system	42
Service / Repair	43
Replacing seals	43
Replacing a heating element	44
Electrical Troubleshooting	46
Vacuum / Pressure Troubleshooting (508DT & 508FS)	48
Cleaning	49
Lubrication	49
Electrical Wiring - 508DT	50
Vacuum Pump 2D351VM - 508DT only	51
Electrical Wiring - 508FS	53
Becker Pump VT 4.10 - 508FS Only	54
Pneumatics 508DT & 508FS	56
Major Parts Listing 508DT & 508FS	57
EC Certificate	59

Thank you for choosing Formech. Please read and follow the below safety instructions before attempting to install or operate your machine.



- > Do not operate the machine until you have been trained and are fully conversant with it.
- > Read and understand all of this user manual.
- > This is a 'single person operating' machine.
- > Check your supply voltage and frequency. Make sure it is compatible with your machine. Your machine's electrical specification is on the plate on the right hand side.
- > You must ensure that the machine is properly earthed and fused.
- > If your machine is not equipped with a moulded mains connector then note that:
 - The earth wire is GREEN with a YELLOW stripe. 
 - The live wire is BROWN 
 - The neutral wire is BLUE 
- > Only suitably qualified personnel should make electrical connections.
- > Turn off the machine and disconnect the power supply when the machine is not in use.
- > The heater and pump on this model are not intended to be left running indefinitely.
- > Never remove any panels unless the electrical supply has been isolated.
- > Always let the machine cool down before attempting to work on it. Some parts of the heater and heat shield become extremely hot during operation.
- > Note the safety warning labels situated on the front and rear panels. Never remove any warning labels from the machine.
- > Note the 'HOT SURFACES' safety labelling on the heater & heater guard. These areas can become VERY HOT.
- > Only use the machine for vacuum forming plastic. It is not intended for any other purpose.
- > Ensure that the area you are working in is properly ventilated and that you are aware of the potential hazards from the plastics you are forming. It is the responsibility of the owner or designated responsible person to assess the risks associated with any dangerous fumes given off and to determine any necessary precautions required such as fume extraction. Contact your plastics supplier to gain information regarding hazardous fumes.
- > The heater and pump on this model are not intended to be left running indefinitely.
- > There is a risk of being burnt when handling heated plastics. Always wear suitable personal protective equipment such as gloves.
- > Ensure that the area surrounding the machine is clean and frequently cleared of finished product and any scrap.
- > This machine is fitted with a dry running vacuum pump. Do not lubricate. Do not allow any liquid to enter the vacuum system. Ensure that moulds are properly sealed to prevent ingress of dust into the vacuum circuit. Severe damage may be caused if the above is not observed.
- > Daily repetitive use of this or any other machine may lead to a) fatigue and loss of concentration b) possible strains.
- > Operators should be trained in the use of correct lifting techniques in order to minimise these effects.
- > Users of this machine should complete regular regular competence tests.

HEALTH & SAFETY - Hazards specific to this machine.



It is vital that any person using this machine and the person(s) responsible for the health & safety is made fully aware of the potential hazards that could arise from the use and misuse.

These can be broadly categorised as: -

1. Electric Shock.

This machine uses Voltages up to 415Vac.



NEVER ATTEMPT ANY REPAIR UNLESS THE ELECTRICAL SUPPLY DISCONNECTED ONLY SWITCH ON WHEN ALL COVERS HAVE BEEN REPLACED.

ONLY A QUALIFIED ELECTRICAL TECHNICIAN MAY WORK ON ANY PARTS CARRYING MAINS VOLTAGE AND SHOULD BE RESPONSIBLE FOR ENSURING THAT THE MACHINE IS IN A SAFE CONDITION BEFORE ALLOWING SERVICES TO BE RESTORED.

2. Burning.

Parts of this machine reach temperatures in excess of 300°C over large areas.

WAIT UNTIL THE MACHINE HAS COOLED DOWN BEFORE SERVICE WORK COMMENCES.



SPECIAL PRECAUTIONS MUST BE TAKEN TO ENSURE THAT ONLY THE MACHINE OPERATOR IS IN THE OPERATING AREA DURING USE.

USE PERSONAL PROTECTIVE EQUIPMENT SUCH AS GLOVES WHEN TESTING THE HEATED PLASTIC, HANDLING HOT VACUUM FORMED PARTS, MANUALLY ASSISTING THE FORMING PROCESS AND TOUCHING HOT SURFACES.

INFRARED RADIATION IS EMITTED BY THE QUARTZ HEATERS, ENSURE THAT ANY EXPOSURE TO THIS TYPE OF RADIATION IS SHORT OR COMPLETELY AVOIDED.

3. Injury from Compressed Air.



Pressures up to 80 PSI (508FS) will be present in large volumes on this machine.

BE EXTRA CAUTIOUS WHEN DEALING WITH COMPRESSED AIR EVEN AFTER THE MAIN SUPPLY HAS BEEN SHUT OFF DANGEROUS RESIDUAL PRESSURE MAY STILL BE PRESENT WITHIN THE SYSTEM.

4. Toxic Fume Inhalation.



When large sheets of plastic are heated fumes will be given off.

ENSURE THAT THE MACHINE IS POSITIONED IN AN ADEQUATELY VENTILATED PLACE. ASSESS THE RISKS OF THE MATERIALS TO BE FORMED PRIOR TO USE.

5. Injury from Trapping.



There is a risk of trapping fingers and hands when loading mould tools. Ensure appropriate care is taken to prevent trapping and use suitable personal protection. Care is required when operating the clamping frame to ensure that fingers or hands are not trapped.

Keep hands clear of the heater rails when pulling the heater forwards.

HEALTH & SAFETY - Hazards specific to this machine.

6. Lifting, Reaching and Stretching.

TAKE CARE WITH LIFTING REACHING AND STRETCHING WHEN PERFORMING THE FOLLOWING ACTIVITIES:

- Operating the manual heater, the loading of materials and unloading of plastic formings.
- Applying manual assistance to formings during vacuum.
- Drilling holes and trimming of mouldings on the machine after forming.
- The fitting and loading of mould tools.
- Loading and fitting of reducing plates and frames.
- Fitting and adjustment of Fans.
- Replacement and maintenance of top frame and table seals.



ENSURE THAT LOCAL LIFTING AND HANDLING PROCEDURES ARE APPLIED AND MONITORED BY A PERSON RESPONSIBLE FOR HEALTH AND SAFETY.

7. Fire.

The sheet auto-levelling system allows the level of heated plastic to be kept constant. There is a risk that failure of the level sensors due to misuse of heaters OR the setting of the compressed air supply to a level that exceeds the operating pressure of pneumatics valve and the machine specification may cause the plastic to be blown into the heaters and to be ignited. Periodically monitor and check the condition of the infrared beam sensors.



ENSURE THE COMPRESSED AIR SUPPLY IS SET TO THE RECOMMENDED LEVEL AND ONLY USE THE HEATER FOR THE HEATING OF VACUUM FORMING PLASTIC MATERIALS.

RISK OF FIRE AS A RESULT OF HEAT AND PLASTICS PRESENTS AN EMERGENCY SITUATION. ENSURE FIRE SAFETY TRAINING IS PERFORMED & CONTROLLED.

IT IS ESSENTIAL TO HAVE FIREFIGHTING EQUIPMENT AVAILABLE AT OR NEAR THE MACHINE. USE DRY POWDER (BLUE) OR CARBON DIOXIDE (BLACK) FIRE EXTINGUISHERS.

8. Airborne Particles.

Particles present in the working area may become airborne during the use of the fan cooling system, when using an airline to blow onto plastics and when the release function is operated without tooling fitted.



ENSURE THAT THE DUST, PARTICLES AND DEBRIS IN THE WORKING AREA ARE KEPT TO A MINIMUM. ENSURE THAT SUITABLE EYE PROTECTION IS WORN.

9. Working at Height.

When installing the fan cooling system, it is necessary to work at an appropriate height.

Ensure that adequate safety precautions are taken to prevent falling from height and that suitable, stable and secure equipment is used to support your weight when working at height. Ensure that you DO NOT work on your own when working at height.



ENSURE THAT LOCAL LIFTING HANDLING AND HIGH LEVEL WORKING PROCEDURES ARE APPLIED AND MONITORED BY A PERSON RESPONSIBLE FOR HEALTH AND SAFETY.

HEALTH & SAFETY - Hazards specific to this machine.

10. Prohibited Uses

DO NOT USE THIS MACHINE FOR ANY PURPOSES OTHER THAN THE VACUUM FORMING AND BLOW MOULDING OF PLASTICS SHEET.

DO NOT USE THE HEATER TO APPLY HEAT TO ANY MATERIAL OTHER THAN PLASTIC SHEET AS PART OF THE VACUUM FORMING PROCESS SUCH AS: FOOD PRODUCTS, ALL TYPES OF PARTICLES, POWDER, DUST, ALL TYPES OF LIQUID, WOOD, PAPER, METALS AND ANY FORMS OF COMBUSTABLE MATERIALS.

DO NOT USE THE TABLE MECHANISM TO CLAMP, COMPRESS, FOLD OR APPLY FORCE TO ANY ITEM UNDER ANY CIRCUMSTANCES.

DO NOT USE THE CLAMPING FRAME TO CLAMP COMPRESS, FOLD OR APPLY FORCE TO ANY ITEM OTHER THAN THE CLAMPING OF SHEET PLASTICS AS PART OF THE VACUUM FORMING PROCESS.

DO NOT USE THE RELEASE TABLE AIR FUNCTION TO APPLY PRESSURE FOR ANY OTHER MEANS OTHER THAN TO RELEASE THE MOULDING FROM A FITTED MOULD TOOL.

DO NOT BLOCK THE PUMP EXHAUST PORT ON THE REAR OF THE MACHINE AND DO NOT USE THIS PRESSURE OUTLET TO APPLY PRESSURE FOR ANY OTHER PURPOSE.

DO NOT USE THE TOP OF THE HEATER OR TOP OF THE HEATER GUARD TO STACK PLASTICS OR OTHER MATERIALS.

DO NOT USE THE MACHINE TO STACK OR LEAN ITEMS AGAINST THE SIDES.

DO NOT USE THE FAN OUTPUTS TO APPLY AIRFLOW FOR ANY OTHER PURPOSE OTHER THAN THE COOLING OF VACUUM FORMINGS AS PART OF THE VACUUM FORMING OR BLOW MOULDING PROCESS.

DO NOT USE THE FAN GANTRY TO HANG ANY ITEM.

DO NOT USE ANY OTHER PART OF THE HEATER TO MOVE THE HEATER FORWARDS AND BACKWARDS OTHER THAN THE HEATER HANDLE.

DO NOT USE OR MODIFY THE ELECTRICAL POWER IN THE CONTROL PANEL TO SUPPLY ANY OTHER DEVICE OR TO APPLY MODIFICATIONS TO THE MACHINE OR ITS FUNCTIONS.

THIS IS NOT AN EXHAUSTIVE LIST OF THE POSSIBLE MISSUSE OF THIS MACHINERY.

THE USE OF THIS MACHINE MUST BE ASSESSED, MONITORED AND CONTROLLED BY THE PERSON RESPONSIBLE FOR THE HEALTH AND SAFETY IN THE ORGANISATION THAT OWNS AND OPERATES THIS MACHINE.

Your Formech Machine is supplied with:



User manual



EC Certificate of conformity



Counter balance weights (508FS)



Heater shed



Table mesh

+ Power lead (508DT)

Power Cable - 508DT

- C19 to BS 1363 Plug (UK & Ireland)
- C19 to CEE 7/4 Plug -Schuko Plug (EU)
- C19 to Nema 6/15 Plug (North America)

Power Cable - 508FS

2.5mm, 3 Core – 3m

Machine footprint

(Dimensions are in mm)

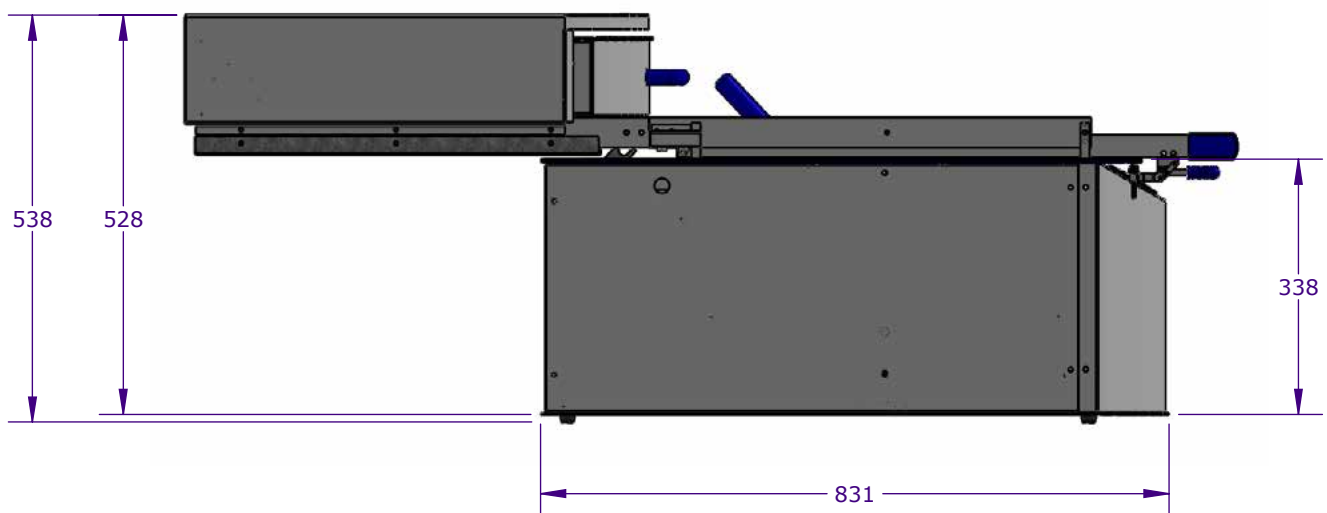
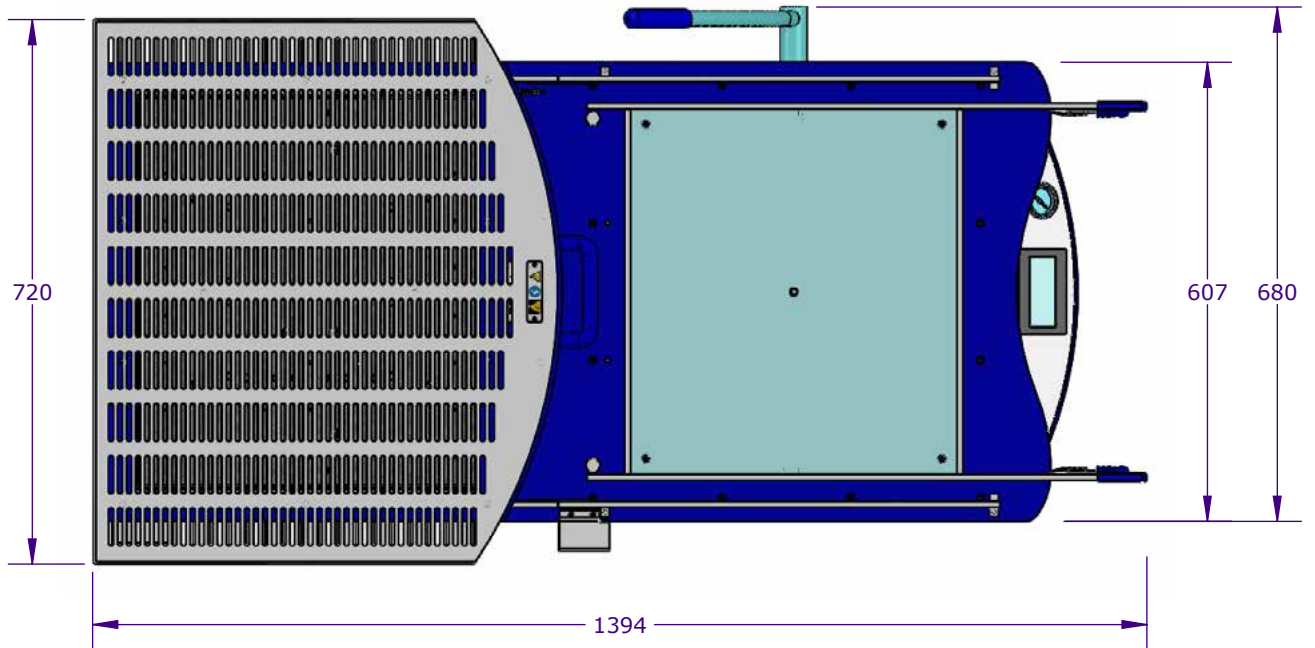

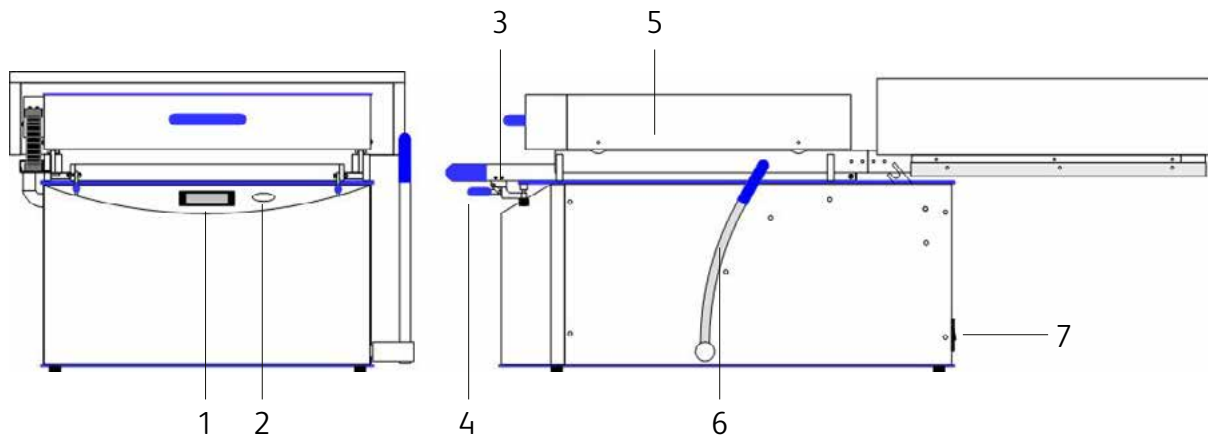

Electrical Specifications

220/240V, 13 amps, 50Hz single phase

208/220V, 13 amps, 60Hz two phases (North America)

Power consumption: 3,2 kW

Mechanical Specifications

Sheet size: 457 x 508mm

Forming area: 482 x 432mm

Max depth of draw: 185mm

Overall width: 720mm

Overall height: 538mm (1250mm with trolley)

Overall length: 1394mm (ASSEMBLED)

Weight: 100kg

Legend

- 1- Touch screen
- 2- Vacuum gauge
- 3- Clamp frame
- 4- Material clamp
- 5- Heater box
- 6- Table lever
- 7- Specification plate
- Power inlet receptacle
- Main fuse
- Power switch ON/OFF
- Air output

Transportation / Positioning

The 508DT will be supplied strapped to a Pallet or in a crate. The machine may unpacked and placed on a bench, table or 508DT trolley. Lift the machine using the clamp handles at the front of the machine and the rear rail lifting handle extensions. Ensure that the structure, size and load bearing capacity of the bench or table is sufficient for the machine weight. A minimum of 2 persons are required to move the machine. In the case of the 508DT trolley, ensure that the 2 machine retaining screws are fitted to the under side of the trolley / Machine. ALL MOVING AND LIFTING MUST BE SUPERVISED BY THE PERSON RESPONSIBLE FOR HEALTH AND SAFETY.

Noise emissions

Noise emissions on the Formech 508DT are less than 70dB(A).

Machine storage

The Formech 508DT must be stored in a dry environment. If the machine is not used for a long period of time, run the pump periodically (once a month).

Machine footprint

(Dimensions are in mm)

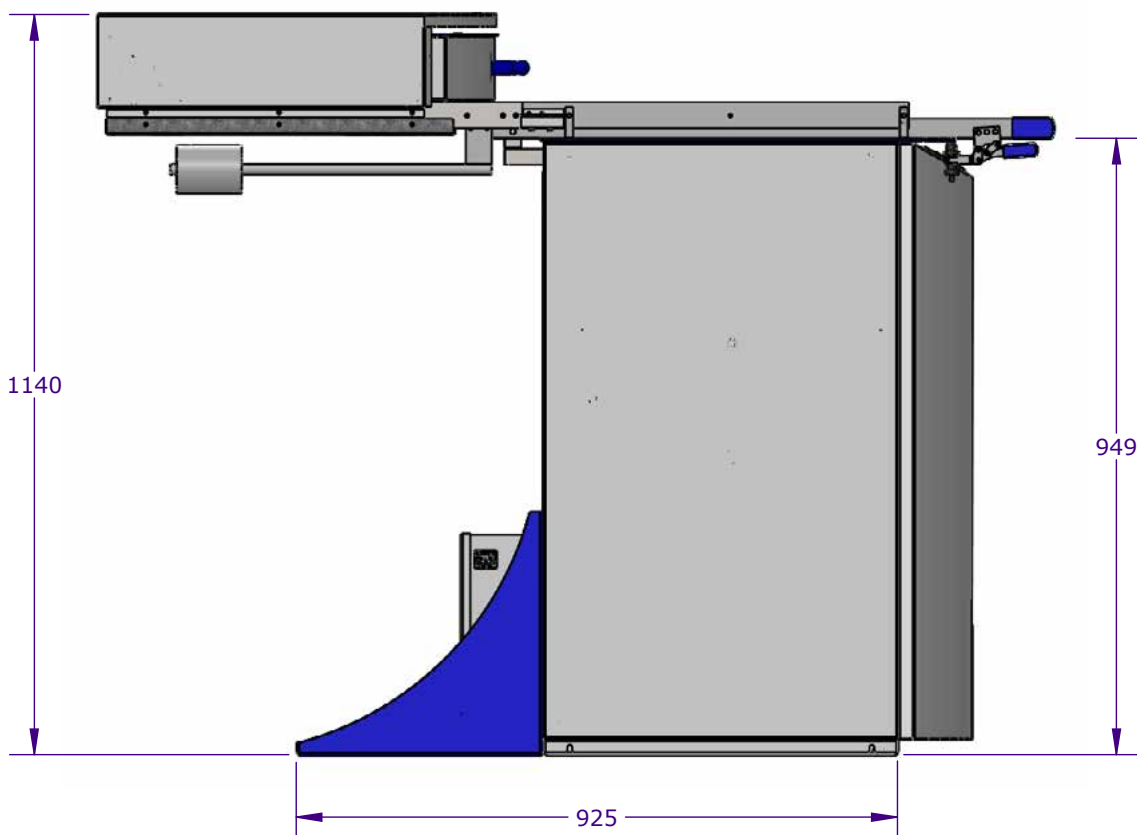
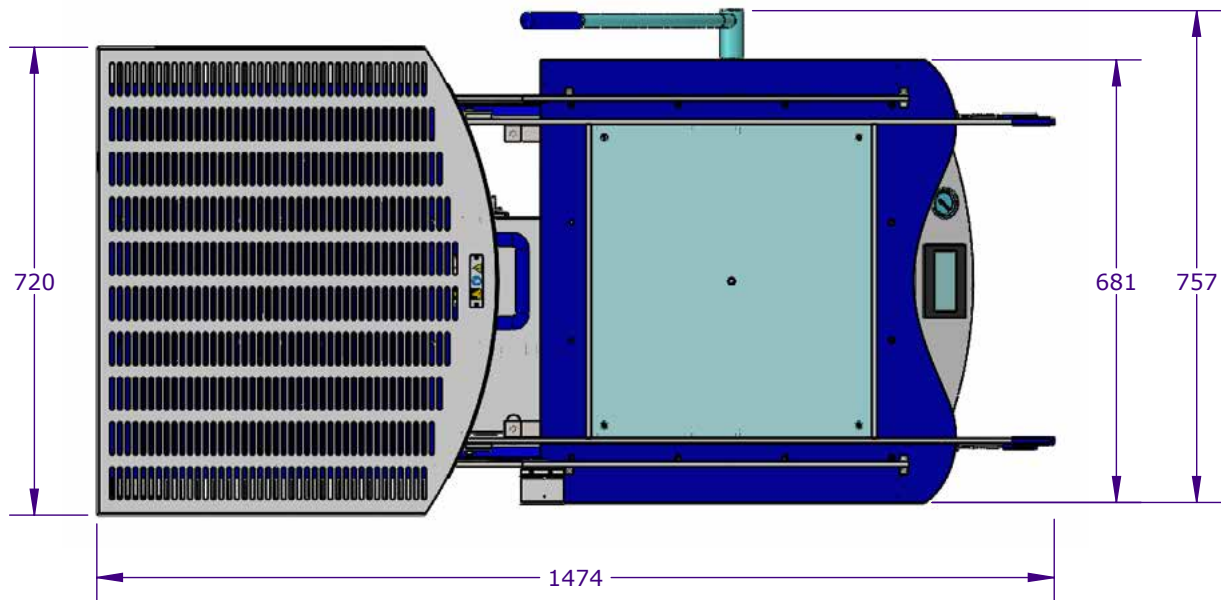

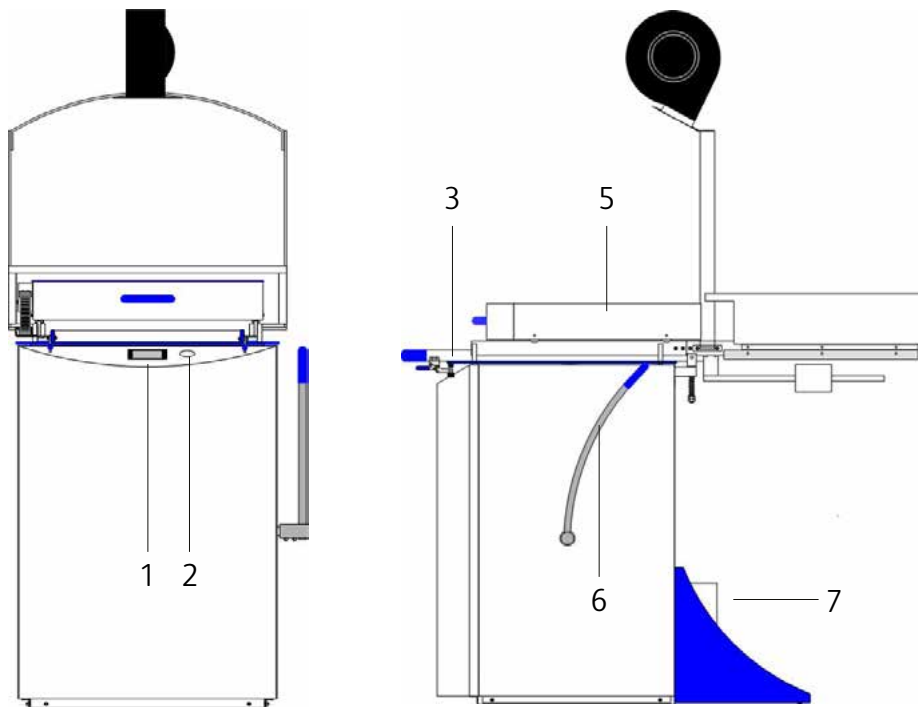

Legend

- 1- Touch screen
- 2- Vacuum gauge
- 3- Clamp frame
- 4- Material clamp
- 5- Heater box
- 6- Table lever
- 7- Specification plate
- Power inlet receptacle
- Main fuse
- Power switch ON/OFF
- Air output

Mechanical Specifications

Sheet size: 508 x 457mm
 Forming area: 482 x 432mm
 Max depth of draw: 290mm
 Overall width: 720mm
 Overall height: 1140mm (1950mm with cooling fan system)
 Overall length: 1474mm (ASSEMBLED)
 Weight: 100kg

Electrical Specifications

220/240V, 20 amps, 50Hz single phase
 208/220V, 20 amps, 60Hz two phases
 (North America)
 Power consumption: 3,5 kW
 Air supply requirement: 80PSI / 5 bar

Transportation / Positioning

The 508FS will be supplied strapped to a Pallet or in a crate. The Machine may be carefully moved from the transportation pallet and situated directly on a firm floor before installation. Ensure that the structure and load bearing capacity of its position is sufficient for the machine weight. A minimum of 2 persons are required to move the machine. Do not attempt to lift this machine without a mechanical aid. ALL MOVING AND LIFTING MUST BE SUPERVISED BY THE PERSON RESPONSIBLE FOR HEALTH AND SAFETY.

Noise emissions

Noise emissions on the Formech 508FS are less than 70dB(A).

Machine storage

The Formech 508FS must be stored in a dry environment. If the machine is not used for a long period of time, run the pump periodically (once a month).

Machine arrangement

1. Touch screen.

Touch sensitive user screen to control the process with the ability to store programs in the memory.

2. Vacuum Gauge.

To indicate the vacuum level achieved during moulding.

3. Clamp Frame.

This holds the plastic material in position during the forming and release processes.

4. Material Clamps.

These clamps fix the Clamp Frame firmly down. After placing the plastic under the clamp frame the material clamps are adjusted by tightening or loosening the black nuts. The levers are pulled up until they are fully over-centre. Adjustment may only be carried out while not under pressure. The rear of the clamp frame is self adjusting.

5. Heater.

This carries the heating elements and is drawn forward by pulling the centrally mounted handle. If the heaters are forward for more than 6 minutes after the timer has completed the heaters will switch off. If the heaters are on the standby position (rear position) for more than 40 minutes then the heaters will switch off. Contact Formech to change the default safety features.

6. Table Lever.

When pulled towards you the table will rise to the upper limit. A further application of pressure will lock the table in this position. During forming the table complete with mould is lifted into the hot plastic and locked in place to ensure a good vacuum seal. At the end of the cycle the table is returned to the lower position by pushing the handle back and away.

7. Air pressure outlet.

The air pressure outlet allows you to supply other equipment that requires air pressure. Air is produced from the exhaust of the vacuum pump. Do not connect compressed air to this outlet. (508DT only)

7. Specification Plate.

This states the model type, electrical supply needed to power the machine & other essential data.

Machine arrangement (continuation)

7. Power connection.

508FS – supplied with 2.5mm cable fitted to connect to a single phase 20amp socket. See Safety section at the beginning of this manual. 508DT – Supplied with C19 plug or C201 receptacle. Note the safety labelling.

7. Mains fuse.

This fuse protects the machine and should only be replaced by another of same type and rating. See Image below – 508DT Only. 508FS – Circuit breakers are fitted to Live and neutral feeds internally.

7. Power Switch ON/OFF.

508DT - See Image below. When OFF, power is cut to all functions. Before commencing any repair work always remove the mains lead from the Power Inlet Receptacle. 508FS – Supplied with a rotary 2 pole switch on the electrical cabinet.

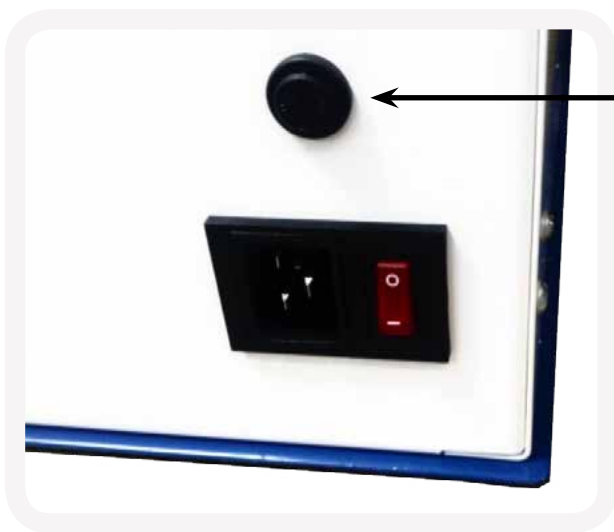

The fuse is positioned separately above the power socket. 508DT.

Heater Layout

508DT Zoning

200W SQE	200W SQE	200W SQE	200W SQE
200W SQE	150W FSQ		200W SQE
	150W FSQ		
125W HSQ	150W FSQ		125W HSQ
250W SQE	250W SQE	250W SQE	250W SQE

Front of machine

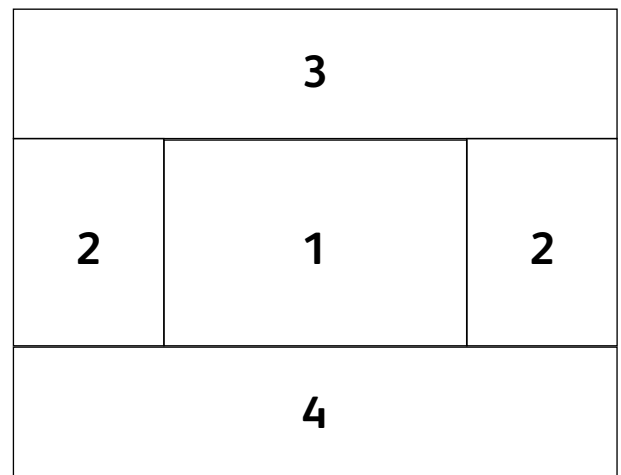

Front of machine

508FS Zoning

250W SQE	250W SQE	250W SQE	250W SQE
250W SQE	200W FSQ		250W SQE
	200W FSQ		
150W HSQ	200W FSQ		150W HSQ
300W SQE	300W SQE	300W SQE	300W SQE

Front of machine

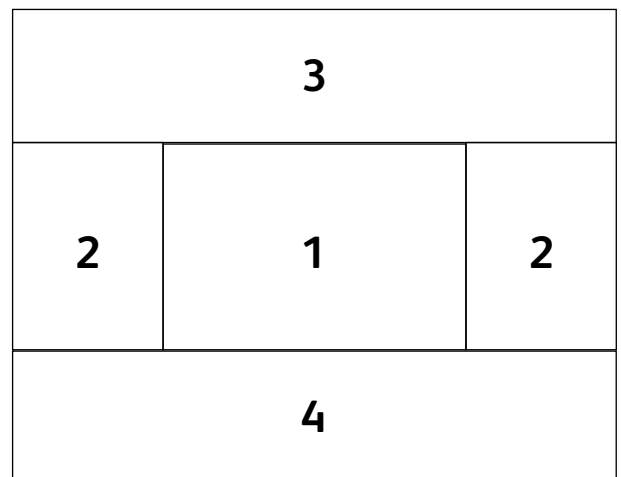

Front of machine

Lifting and Handling - 508DT only



The machine is shipped with two lifting bars fixed to the rear of the heater rails. Once the machine has been positioned on either the trolley or the table top, remove the lifting bars before the heater guard can be fixed in place.



Remove the 2 screws on both sides and remove the lifting bars. Store the lifting bars for future use.



Slide the heater guard onto the front rail link bars.

Heater Guard - 508DT & 508FS

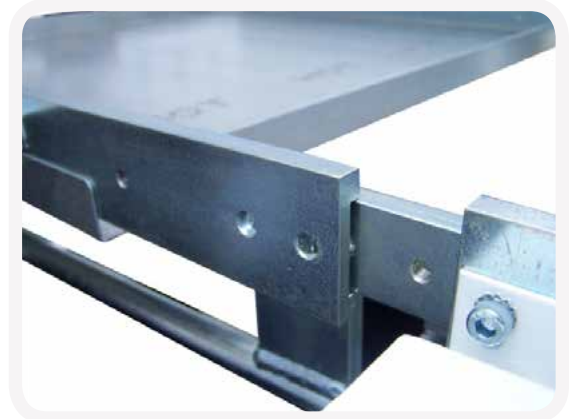

- 1 Slide the heater guard rails onto the front rail link bars as shown. Take care to fit evenly so that the front and rear rails meet and the fixing holes are aligned.
- 2 Fit the 4 screws – 2 each side – using an 8mm spanner. Ensure all screws are tight and that heater rails are aligned.
- 3 The heaters are kept in the front position for transit by a screw that is positioned mid way along the front heater rail.

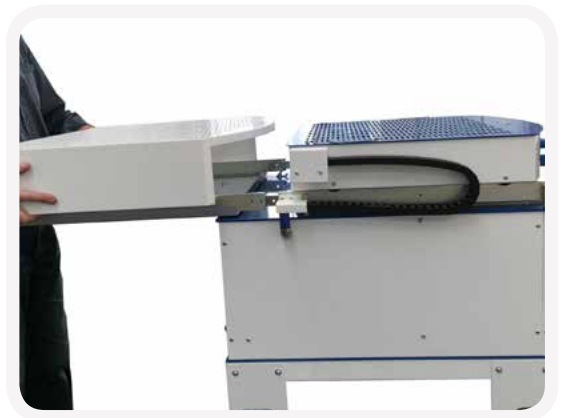

Remove the screw from the side to allow the heaters to be moved backwards.



Fitting reducing windows (optional)

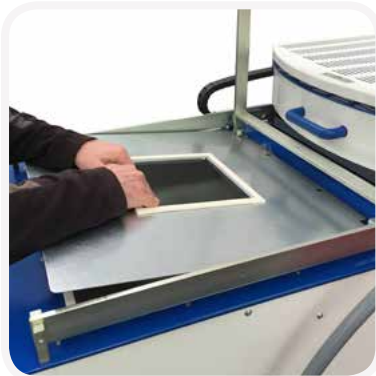

Lift the clamp frame and place the lower reducing window in the machine.

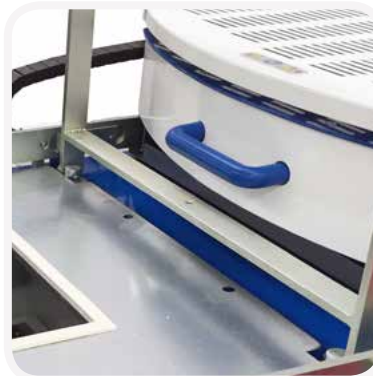

The lower reducing window locates over the cap head screws at the rear.

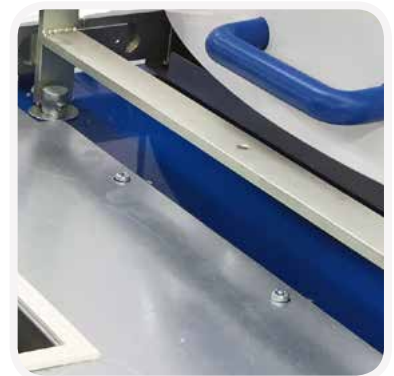

In order to locate the window, position the plate holes 1cm beyond the cap head screws and pull back to locate.

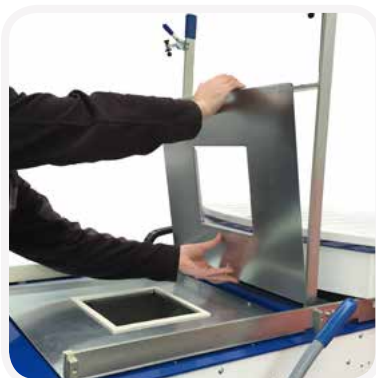

Place the upper reducing window in the clamp frame at the rear.



Then locate it at the front of the clamp frame.



Close and lock the clamp frame. At this stage, you may have to adjust the toggle clamps.

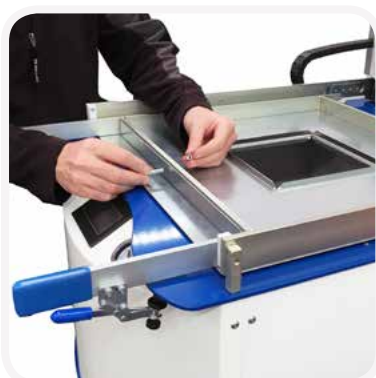

Fit the bolt and the nut to secure the window to the clamp frame.



Do the same on the back of the reducing window. Make the nuts and bolts finger tight. Do not use a spanner.

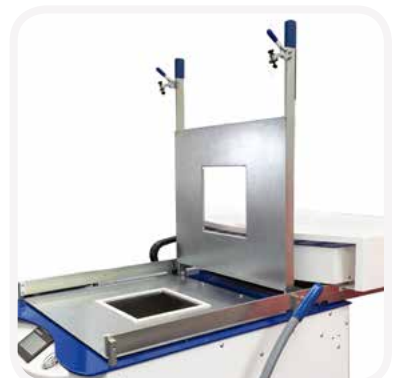

Reducing windows correctly fitted to the machine.

Air Outlet connection - 508DT only

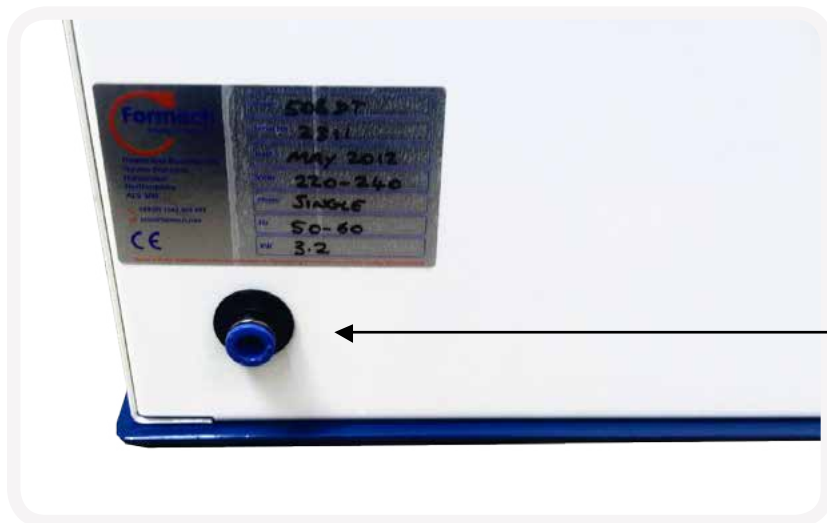

Fitted with an 8mm tube Air outlet connector for dome blowing.

Counterweights

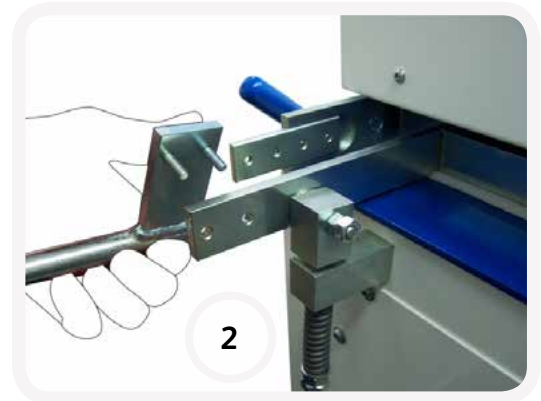
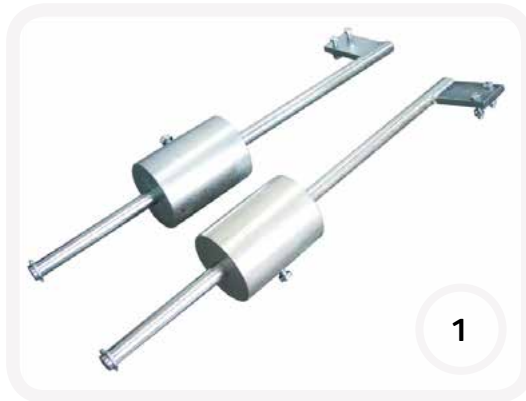

- 1 Remove the nuts and washers from the counterweight arms.
- 2 Lift the Counterweight arm with the screws and insert in corresponding holes of the clamp frame. 3

Ensure the counterweight arm is fitted to the outside of the clamp frame.

- 4 & 5 Fit and tighten the washers and nuts removed in 1
- 6 Repeat for both sides of the clamp frame.

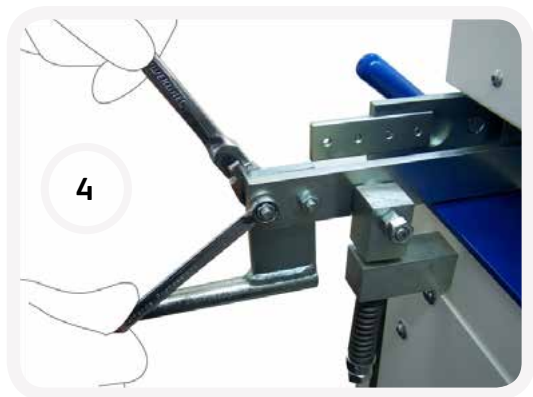
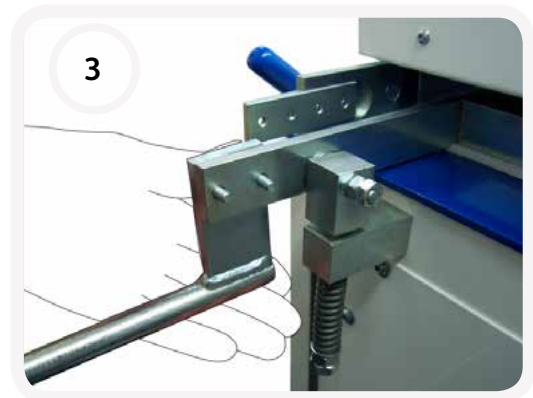

Castor option

The 508FS is designed to be fitted with castors.

If the castors are ordered with the machine then the unit will be supplied as follows:

- 2 Braked castor wheels pre-fitted to the rear stabiliser.
- 2 castor wheels with fixings to be fitted to the underside of the main unit.

ALL MOVING AND LIFTING MUST BE SUPERVISED BY THE PERSON RESPONSIBLE FOR HEALTH AND SAFETY. ENSURE THAT THE MACHINE IS FULLY SUPPORTED AND IS STABLE BEFORE WORKING UNDER PARTS THAT MAY TRAP OR CRUSH.

It is best to fit the front wheels when the unit is on the delivery pallet or slide the unit onto suitable sized blocks to raise the main body off the ground. The castor wheels are fitted to the front corners of the machine.

Fitting the Castors

- Move the machine so that the front overhangs the pallet / blocks and locate the fixing holes.
- Fix each of the castor wheels with the M10 screw, split washer and washer. Ensure the screws are tight.
- Assemble the rear stabiliser with fitted locking castors – refer to next section.
- Carefully remove from pallet / supporting blocks.

ALWAYS ENSURE THE REAR WHEEL CASTORS ARE LOCKED WHEN LOCATED AT THE WORK AREA.

If the castors are supplied as a retrofit item then the front fixing holes will be blocked with screws fitted internally. These screws will need to be removed before fitting the wheels.

- Remove the crank handle.
- Remove both side panels by removing the 2 M6 screws holding the top of the panel accessible from the forming area. Loosen the panel lower retaining screws and lift off the panels.
- Remove the screws and refit the side panels and the crank handle ensuring the fixings are refitted correctly.
- Fit the front castor wheels as above and fit the rear locking castor wheels to the rear stabiliser using the fixings supplied.

If the unit is supplied with the castor wheel option and the machine is to be used before fitting the wheel castors then the auto-level and pre-stretch air will escape through the wheel mounting holes until the wheels are fitted or the fixing holes are blocked.

Fitting the rear stabilisers

The triangular supports and the connecting crossbar at the rear of the machine need to be assembled before being attached to the rear of the main body of the machine.

The triangular supports are interchangeable between the left and right hand side. The white crossbar needs to be bolted to the supports from the underneath and then the four bolts tightened to create a rigid framework.

This is then bolted to the rear of the main body using four M6 cap head screws.

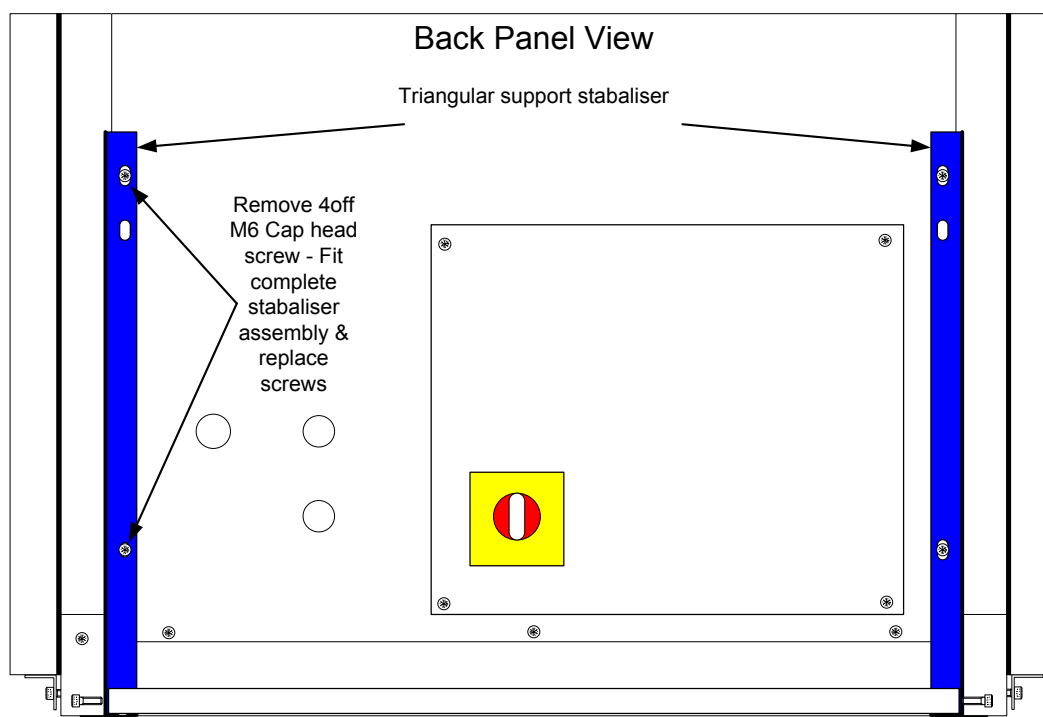
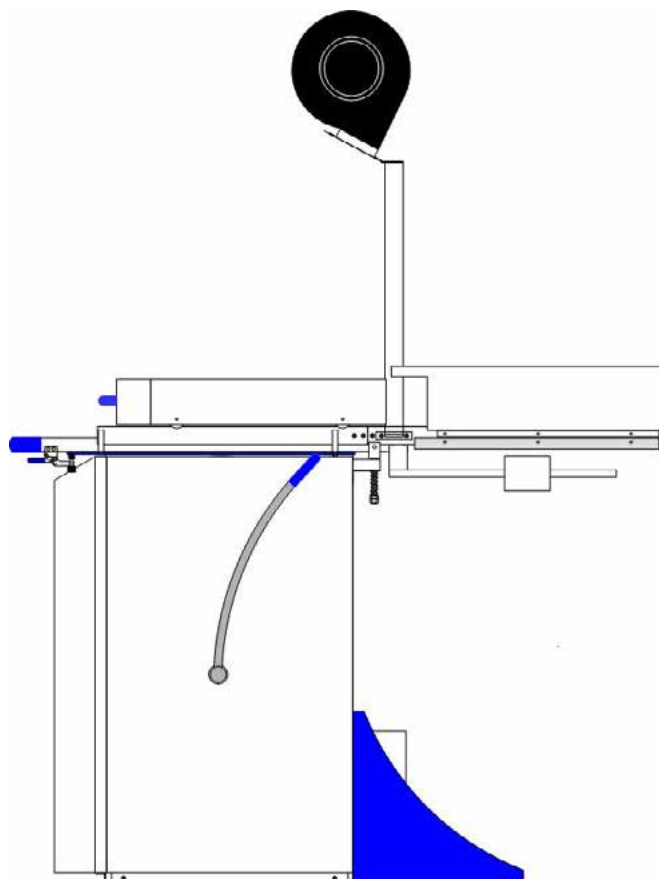

Cooling fan option

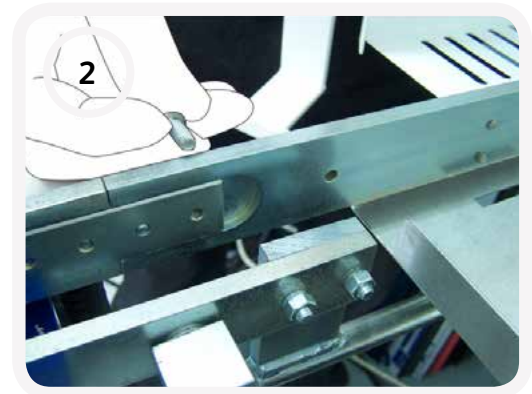

- 1 The Cooling fan option consists of:
 - FAN & Power lead
 - L&R Fan Posts
 - Fan Crossmember.
- 2 Remove the rear screw of the rail link Fan post .
- 3 Fix and tighten with the screw and a 2nd mounting screw for both posts.
- 4 & 5 Fix the crossmember to the fan posts using the fixings supplied. Position the fan grill towards the front of the machine. 6

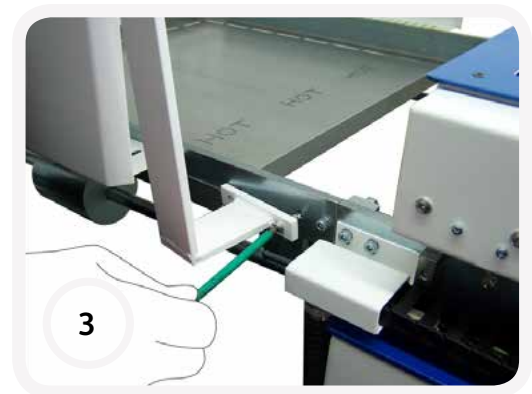

Cooling fan option (continuation)



- 7 Position the fan unit on the crossmember.
- 8 Insert the mounting screws.
- 9 Fit the Fixing nut to the screw & tighten.
- 10 & 11 Insert the IEC connector into the receptacle located on the electrical box.
- 12 Secure the cable with the fixings supplied.

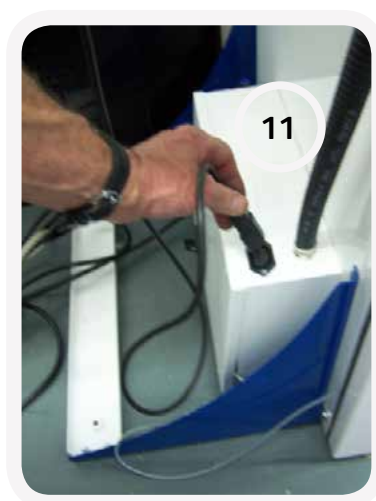

Compressed air connection - 508FS only

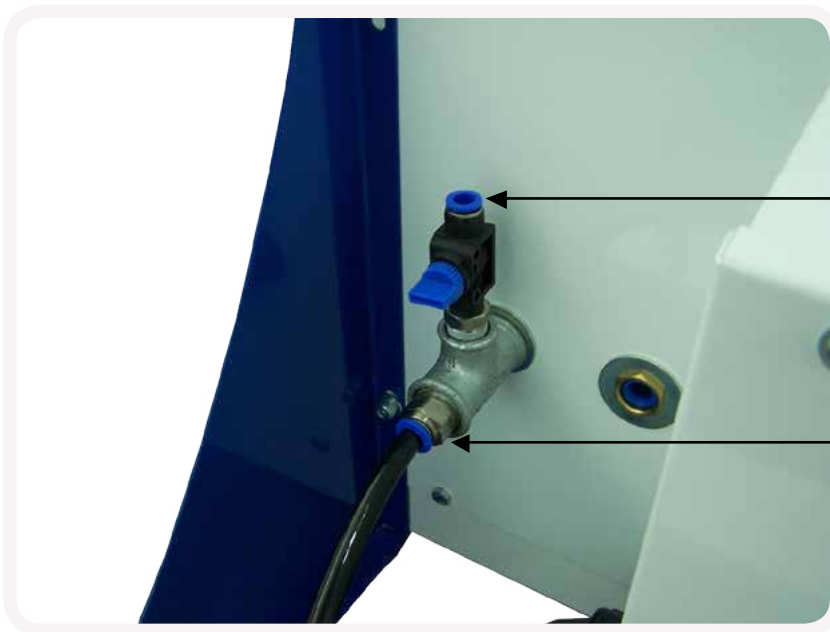











8mm tube air supply outlet valve for use with ancillary equipment (eg. Air blow gun).

10mm tube air inlet connection. A 3 metre air hose is supplied with the machine with a 1/2inch BSP fitting if required.

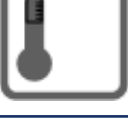



The air consumption will be dependant upon usage and therefore it varies from customer to customer.

Air requirements for the 508FS: 80PSI / 5 bar

Introduction to the 508 control system - Operating buttons and icons

	<p>Heater Enable Enables the heaters on the main menu screen. Heaters will shut off after 1 hour if there if the machine is unused.</p>
	<p>Start Opens the load options screen to allow selection of saved parameters or manual operation.</p>
	<p>Manual operation Allows manual operating of the machine functions. Default heater settings are applied. Timers will count up.</p>
	<p>Load from Memory Allows previously saved operating parameters to be used.</p>
	<p>Settings This button provides access to the settings screen where the operating parameters may be adjusted and saved if required.</p>
	<p>Heater Power Setting Allows adjustment of the heat power for each zone. Adjustable in 1 % increments.</p>
	<p>Heater Standby setting This feature allows reduction of the heater power level when the heater is in the rear position.</p>
	<p>Page Forward This operation will advance to the next page in the help screen and memory settings screens.</p>
	<p>Page Back This operation will return to the previous page or screen.</p>
	<p>Save Used to save operating parameter settings.</p>
	<p>Heater Timer Shows the heater time. Press on the time value to adjust the heat timer on the operation screen. The time cannot be adjusted in manual mode.</p>

Introduction to the 508 control system - Operating buttons and icons (continuation)

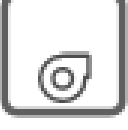
	<p>Vacuum This operation will latch the pump and the vacuum valve ON to apply vacuum to the table hole.</p>
	<p>Release This operation will apply compressed air to the table hole. This function does not latch but will unlatch the vacuum. Press & hold to run.</p>
	<p>Pre-Stretch This operation will turn on the compressed air valve to allow air to flow into the sealed cabinet. This function does not latch. Press & hold to run. 508FS only.</p>
	<p>Auto-level This operation enables a sensor to provide automatic levelling of the sheet level during heating. Compressed air is applied under the heated sheet when the beam is broken. This button latches and may be enabled / disabled at any time. 508FS only.</p>
	<p>Fan Timer This operation will latch the fan on for the time set for loaded settings. The fans will turn off when the time has elapsed. 508FS only.</p>

Initial Requirements (508DT & 508FS)



1. Ensure the machine is turned on and has the appropriate air supply (508FS only).



2. With the heater fully back, raise the table to the top position by pushing the table lever closer to you.



3. Place your mold onto the table. A sheet of wire mesh is supplied with the machine to assist with Vacuum air flow under the mould tool.



4. Fix the mould tool in place. Lower the table by pushing the table lever away from you.



5. Open the material clamps (see general arrangement) and raise the clamp frame. Ensure the counterweights are set so that the clamp frame is correctly balanced (508FS only).





6. Pull the clamp frame down and close the two material clamps. The plastic should completely cover the white seals around the aperture. Adjust the toggle clamp screws to properly grip the plastic. ⁽¹⁾

⁽¹⁾ The rear of the clamp is spring loaded. The pre-load spring tension at the rear of the clamping frame can be adjusted by moving the position of the two lock nuts (508FS only) – see section dealing with adjustment.

Main Menu



Press  to turn ON the heaters. Allow 15 minutes for the machine reach its operating temperature.

The 508 has a 'HELP' feature accessible by pressing the  button on many of the user screens. Descriptions of the screen icons and buttons are shown on these screens in the language selected.

HELP screen language options are changed by pressing on the language button to select the language required. Press  to open the Load Options screen:



Press  to open the operating screen in manual mode.

508DT Basic operation

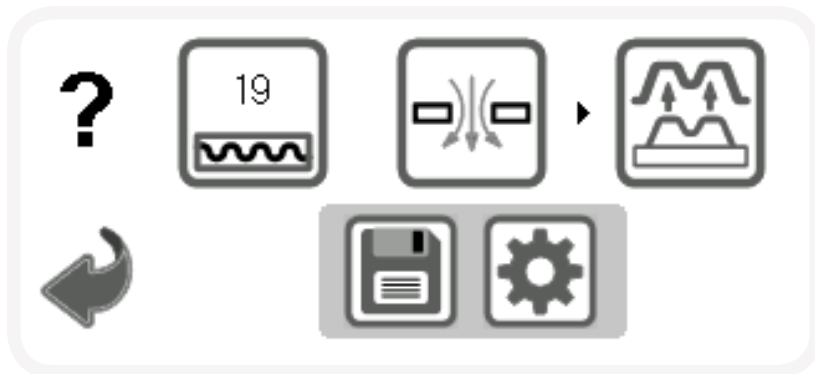



The 508DT Manual operation screen will open as shown.

The Heater timer value on the HEATER button will count UP when the heater is pulled forwards and stop when pushed back. The Vacuum button will latch the vacuum ON when pressed. The Release button will momentarily activate the pump pressure when pressed.

Heater settings may be changes via the settings button. In manual mode the heaters are set to the default values. The Save button will use the settings of the timers shown and import them to the settings screen to edit and save as required.

The following section explains the 508DT vacuum forming process:

- Pull the Heater forwards over the clamped plastic.
- As the plastic heats up it may begin to rise slightly. It will then soften and begin to drop back.
- When performing an initial forming it will be necessary to check the progress of heating as this will vary with plastic type, thickness and colour. Push the heater back slightly to test the softness of the plastic manually or to observe its state. Continue heating until it is soft enough to form. When the plastic softness is correct push back the heater fully back.
- Lift the table until it is fully raised. Then press the VACUUM button  to latch on the vacuum. The moulding will form around the tooling.
- Once the plastic has cooled sufficiently the RELEASE button  may be pressed to blow the moulding off the mould. Too long or too soon a release may distort the moulding.
- Once released the moulding is now complete and the table may be lowered. Ensure the table has reached its lower position. Release the clamp frame to remove the moulding for inspection.
- Review the results and determine the parameters required to produce the forming. @Use the save settings feature to set and record the values for later recall.

508DT Settings

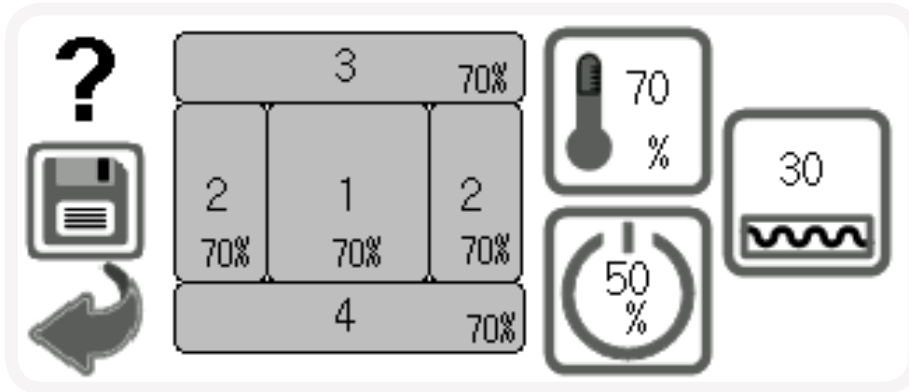

This screen will open when the settings button  on the 508DT operation screen is pressed.

The Manual mode default heater settings are shown above.

Heater power settings are adjusted by pressing on the heater button  and changing the value using the pop-up keypad.

Once set to a required value, press on a zone and the value will transfer to that zone. Repeat the process on the other zones to set the required heat power values.

Heat power may be set in 1 % increments to achieve the required heat profile.

The standby feature allows the Heater to idle at a lower heat power when in the rear position. The default level is 50% and is adjustable in 5 % increments.

Press on the standby button  to adjust. The following screen will open:

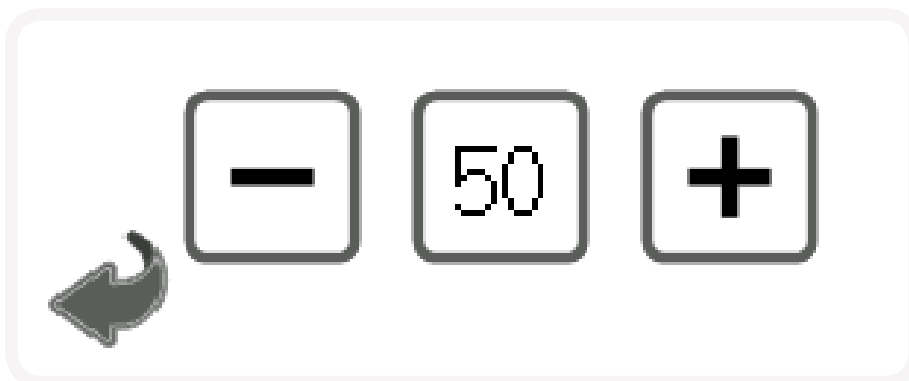

Use the + & - buttons to adjust the standby level and the back button when complete.

Use the back button to exit the settings screen and return to the operation screen.

The save button  on the operation screen will also open the settings screen but will also bring the timer value from the manual operation across to the settings screen.

The heater power and timer parameters may be edited before saving into memory. The timer button will open a Pop-up keypad for adjustment of the parameter. When complete, press the save button on the settings screen to select a memory slot to save.

There are 20 memory locations.

508DT Saving Parameters to Memory

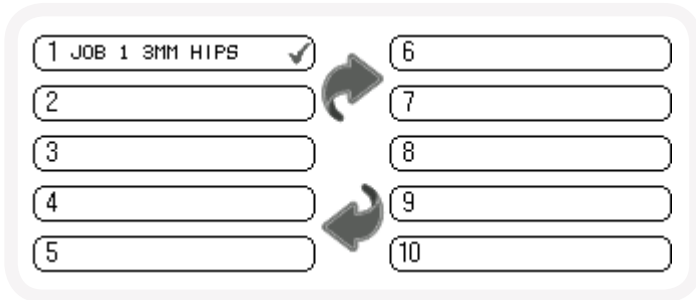

When save is pressed on the settings screen the screen shown above will show displaying the available memory slots. Press the forward arrow to advance to memory positions 11-20. Press the Back arrow to return to the settings page if required. Press on a previously saved memory slot to change an existing record or select a new slot to save as required. When a memory position is selected the following screen will open.

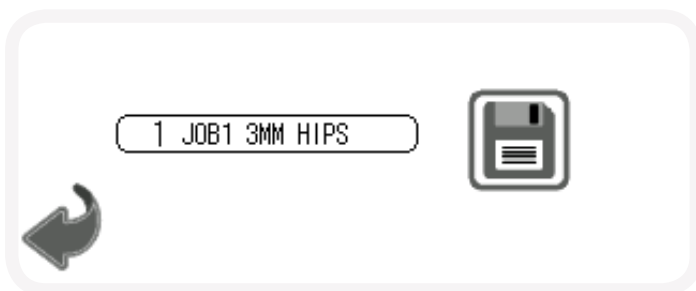

Press on the memory title to edit the title using the pop-up key pad as required. Press the save button when complete. 508DT Loading previously saved parameters from memory.

Press the load button  on the load options screen to load previously saved parameters. The load select screen will open.

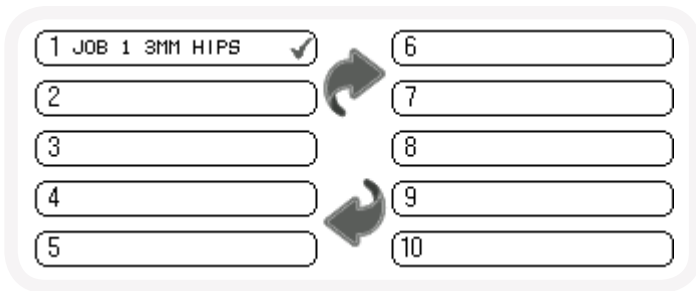

The previously loaded memory slot will be remembered and a ✓ will show next to the slot.

User the forward arrow to scroll to memory slots 11-20 and select the memory parameters as required. The program memory operation screen will open. The following section explains the operating differences.

508DT Operating using saved parameters

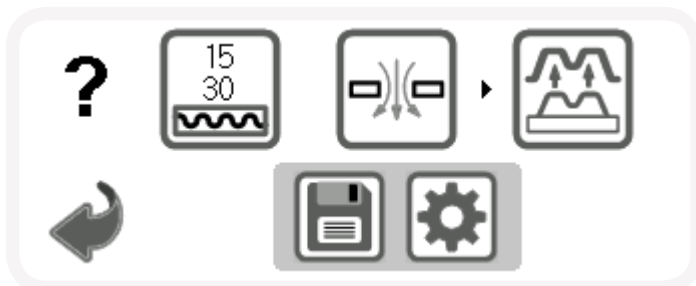

The operating screen shown above will open. 2 values will show in the heater timer button.

The lower value shows the timer parameter for the selected memory.

The top value shows the actual timer value. When the heater is pulled forwards the timer will count down.

When the timer reaches zero the timer buzzer will sound the timer value will continue and show a negative value to indicate that's it has passed zero. All other buttons operate the same as previously described. Heater power settings can be adjusted as previously described using the settings button.

When the SAVE button is pressed the actual heat time, including its negative count, will be carried over to the settings screen for editing and saving as previously described.



508FS Basic Operation



The 508FS Memory Operating screen is shown. The Heater timer function is the same as the 508DT.

The manual operating heat timer function is also the same showing only a single count up timer.

There are 4 main differences between the 508FS & the 508DT as follows:



1. There is a pre-stretch function  to allow the plastic material to be stretched prior to forming.
2. There is an auto-leveling function  to prevent drop and allow more even heat.
3. The 508FS has cooling fan option. When activated a cooling fan button and timer will be shown.
4. Compressed air is used for three release function.

The settings and save functions operate the same as the 508DT.





The operating screen with the FAN option activated is shown on the left.

The following section explains the 508FS vacuum forming process using the additional features:

- Pull the Heater forwards over the clamped plastic.
- As the plastic heats up it may begin to rise slightly. It will then soften and begin to drop back.
- Activate the Auto-level if required by touching the button so it shows negative image . If the plastic is sagging and not being heated evenly then the auto-level feature is used to keep the plastic level while the heater is forward and until ready to form a mould.
- When performing an initial forming it will be necessary to check the progress of heating as this will vary with plastic type, thickness and colour. Push the heater back slightly to test the softness of the plastic manually or to observe its state. Continue heating until it is soft enough to form. When the plastic softness is correct push back the heater fully back.
- Press the Pre-Stretch button  to inflate the plastic before moulding if required. This feature is particularly useful if the mould is high because it keeps the plastic at a more even thickness throughout the moulding. If the moulding is quite high it may be necessary to pre-stretch the plastic before moulding takes place.
- Lift the table until it is fully raised. Then press the VACUUM button  to latch on the vacuum. The moulding will form around the tooling.

508FS Basic Operation (continuation)

- Once the plastic has cooled sufficiently the RELEASE button  may be pressed to blow the moulding off the mould. Too long or too soon a release may distort the moulding.
- At the appropriate time when the plastic has formed around the mould tool the fans may be turned on to start the plastic cooling process – press the FAN button . When the moulding is adequately cooled, press the fan icon again to turn it off.
- Once released the moulding is now complete and the table may be lowered. Ensure the table has reached its lower position. Release the clamp frame to remove the moulding for inspection.

Review the results and determine the parameters required to produce the forming. Use the save settings feature to set and record the values for later recall.

508FS Fan system activation

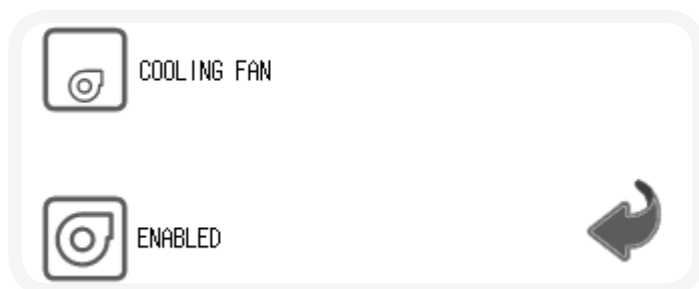

Enter the HELP screen and scroll forward to screen shown above.

Pressing the FAN button  will allow the fan system to be activated and the fan button and timer will show in the operation and settings screens.

Cooling fan operation

The Fan timer function operates the same as the heater timer. In manual mode it will time UP and the value transferred to the setting screen using the save feature. When saved parameters are loaded the timer will count DOWN and the fan will turn OFF at the end of the time. Press again to restart the fan and timer.

The following items can be purchased for your 508 vacuum forming machine:



1. Service kit



2. Reducing windows



3. Blow mould windows



4. 508DT Machine trolley



5. 508FS cooling fan
& gantry

1. It is unlikely that you will need to service or repair your machine for many years provided you follow the maintenance information contained in this manual. However, the table and clamp seals, which are considered to be consumable items, will need to be replaced depending on the usage of the machine. Therefore this kit contains the essential consumables (seals and pump filter) to ensure a good performance of your machine year on year.

2. Formech has available 2 standard sizes of reducing windows for the 508, with apertures of 228 x 204mm and 432 x 229 mm. Formech can also produce special size reducing windows. For more information please contact our sales department. See page 13 for installation.

3. You can use your vacuum forming machine to do blow moulding by fitting a special circular reducing window to your machine. The maximum diameter you will get on the 508FS is 430mm. For more information please contact our sales department.

4. The Formech trolley allows you to easily move your 508DT machine. The 2 locking castors assure the trolley remains in position all the time. Underneath there is also space to store plastic material and moulds. The size of the trolley is the following - depth: 780mm, height: 720mm, width: 608mm

5. Overhead gantry and single 125W fan to cool formed material and shorten cycles times.

All tools should be mounted on a baseboard. They should not have undercuts and must be produced with slightly angular sides ('draft angle') to aid release. Vent holes are needed to allow the air to be evacuated from pockets and sharp angles on the tool. Providing these holes are kept small (1mm diameter or less) they will not leave marks on the surface of the finished moulding.

Tools made from wood or medium density fibreboard (MDF) are easily constructed and can give short runs of good quality mouldings at a low cost (see notes page 36). The use of close-grained wood will avoid grain patterns appearing on the mouldings.

Plaster of Paris may be used for one-offs but the plaster must be allowed to properly dry out. (See notes below)

Aluminium tools have the advantages of carrying fine detail and being more resistant to both distortion and surface damage. Aluminium tools should be pre-heated before use. A cool metal mould will absorb some of the heat from the plastic sheet before it can take up the full definition.

Resin tools combine most of the advantages of metal moulds with relative ease of manufacture. Various resinous materials are commercially available especially for vacuum forming tool production.

Repairs to the vacuum circuit can be costly. The use of talc as a release agent is not recommended. It may clog the vacuum pump, valves and hoses.

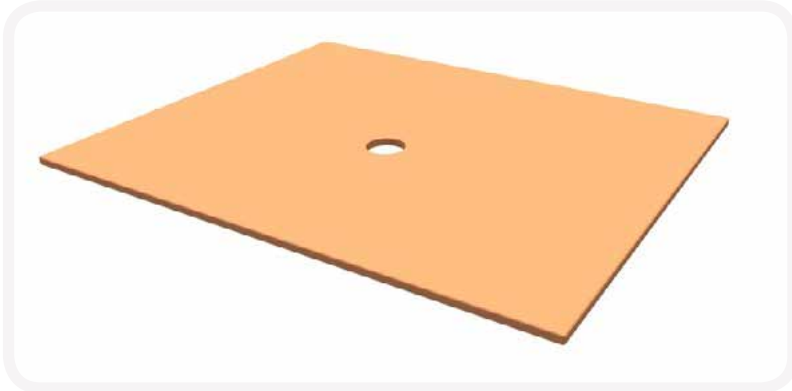

MDF Baseboard



Aluminium Baseboard

NOTES:

Porous mould materials such as wood and plaster should be properly sealed to prevent the vacuum pump from sucking out any moisture or sawdust, loose plaster etc. The vacuum circuit may quickly become blocked with dust or slurry if moulds are not properly sealed.

As the plastic cools after forming it will contract, gripping the tool tightly. If the tool has been made with sloping sides and has a good surface finish it will release more easily. Where the draft angle must be kept to a minimum a release agent may be used to assist release.

Sealed moulds will usually release more easily. Silicon based release agents may be used on more difficult moulds. Silicon based release agents are rapidly absorbed by porous (unsealed) moulds, rendering them ineffective.

The baseboard can be made from either MDF or aluminium and needs to be 12.00mm (1/2") thick. The vacuum hole can be 19.00 – 20.00mm (3/4") diameter and needs to be positioned in the center of the table.

The baseboard has to be 4/5mm shorter in both directions than the forming aperture of the machine e.g. Forming aperture 482mm x 432mm = baseboard size 478mm x 428mm.

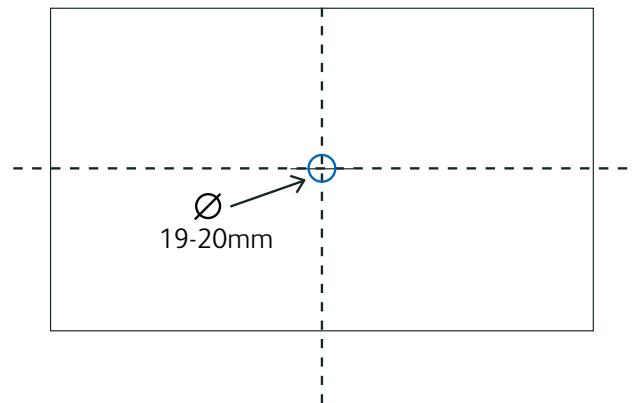

508DT/FS standard baseboard

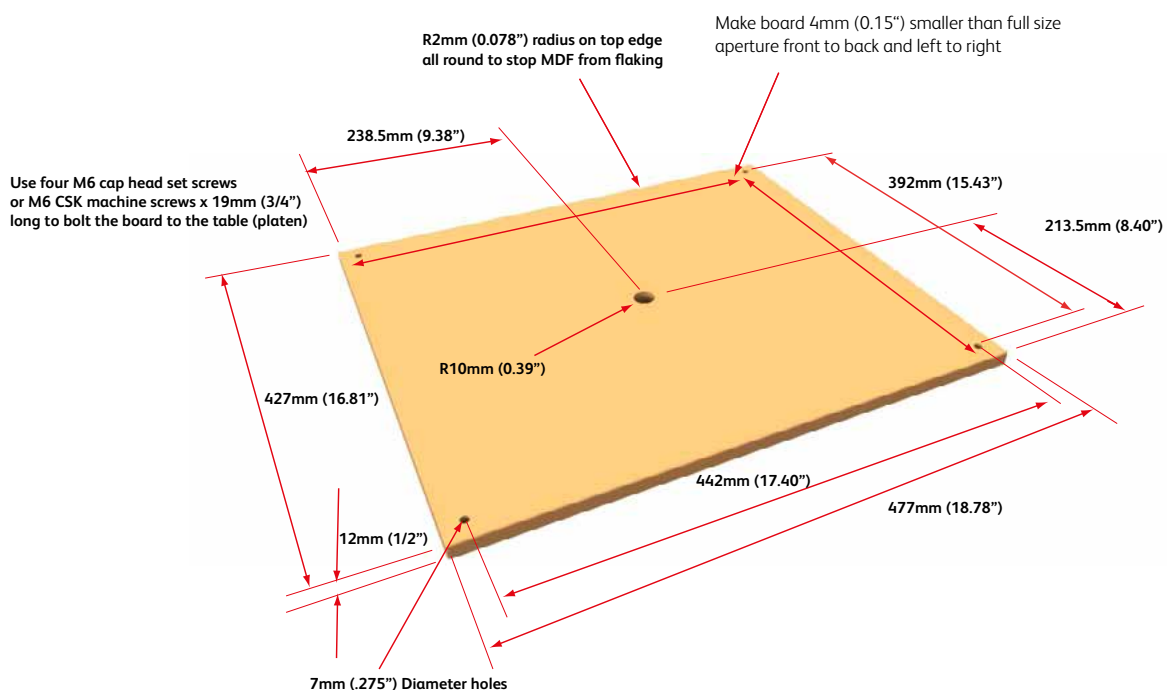

508DT/FS standard baseboard (continuation)

In plan view of the standard baseboard

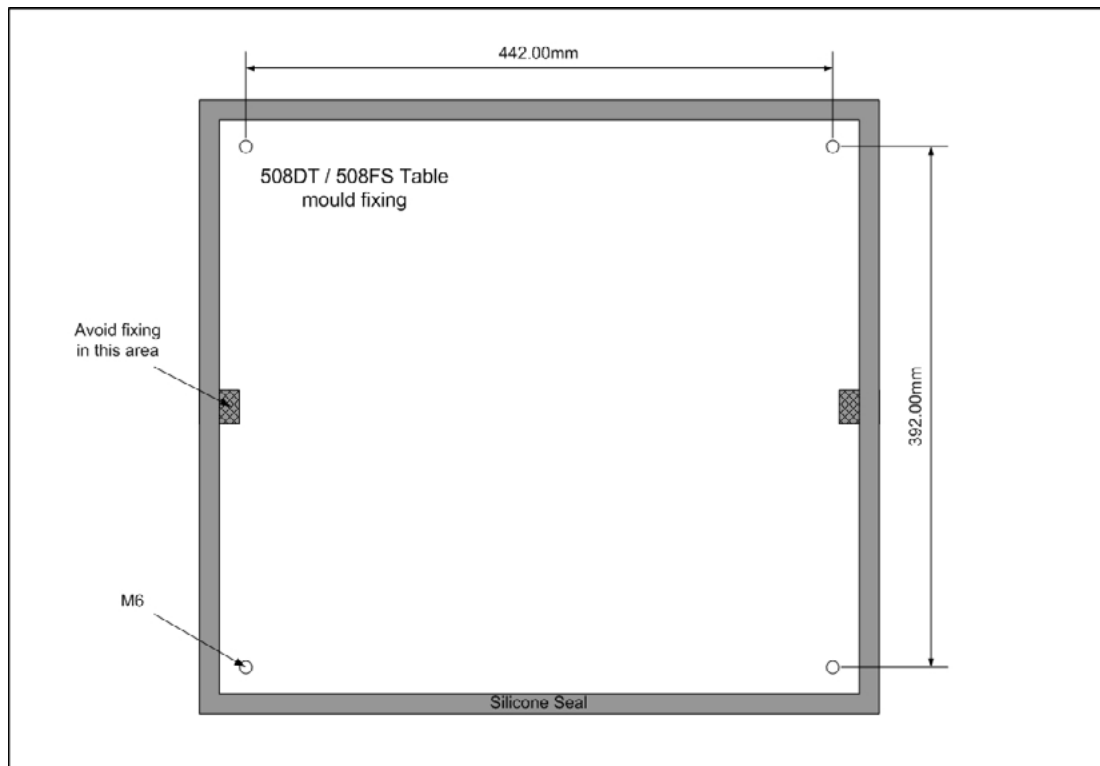

508DT/FS reducing window baseboard

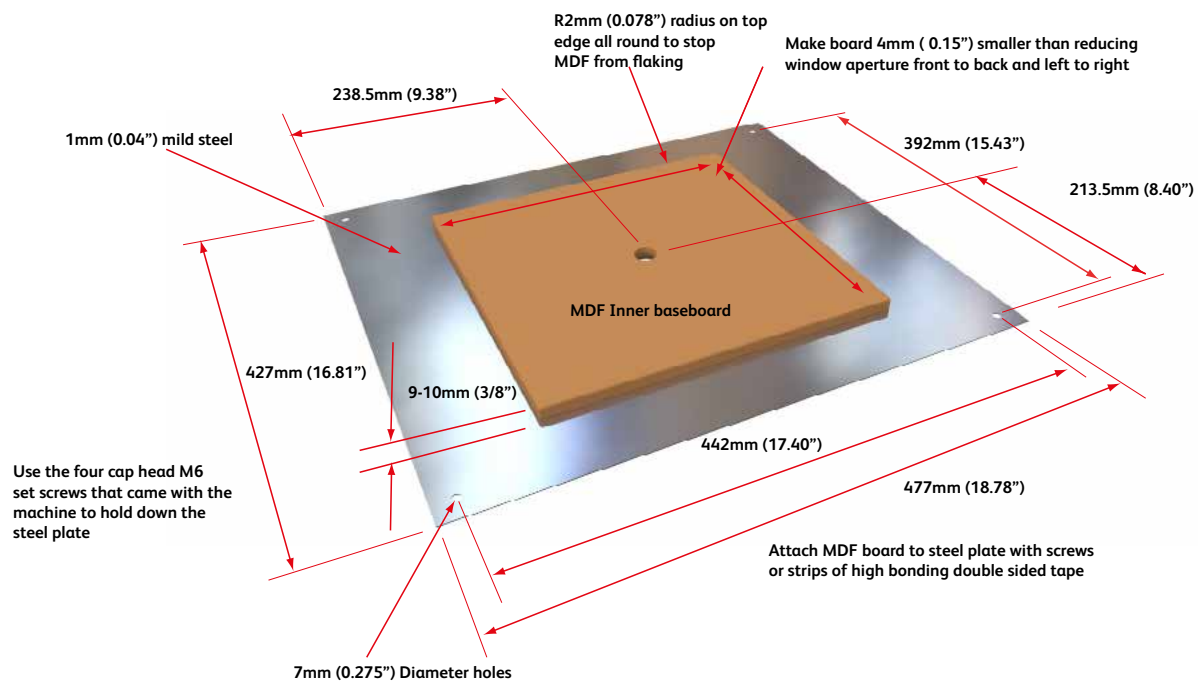

Plastic sheet is commercially available in a wide variety of grades, thickness and colours. Materials such as styrene and PVC are most suited to vacuum forming. Other materials such as acrylic, polypropylene and polycarbonate will mould but difficulties may be encountered.

It is not within the scope of this manual to attempt to list all the potential problems and their solutions. It is recommended that the newcomer to vacuum forming gains experience and confidence with easily formed materials before moving onto the more difficult materials.

Formech has available a Vacuum Forming Guide which will cover some of these topics in more details. Please contact Formech to gain access to this guide.

After forming

After forming, most plastics can be subsequently heat formed to add such details as folds or clips. Although many plastics can be printed, and in some cases painted, the presence of release agent used to help free a tight moulding may make the surface resistant to further decoration.

Trimming

An ideal moulding will be ready for use when removed from the machine and requires no finishing. However, most mouldings do require trimming before they can be used.

There are numerous methods available for this process.

Thin materials can be trimmed with a sharp knife. Shaped cutting dies can be used to cut out intricate shapes. If no flange is required on the finished product then a trimming saw mounted in a pillar drill will cut the moulding in a horizontal plane to free it from the surrounding material.

In mass production environments the range of equipment available for this requirement encompasses clicking presses, roller presses, routers, horizontal band saws, water jet cutters, laser cutters and many others.

Formech has available a Vacuum Forming Guide which will cover some of these topics in more details. Please contact Formech to gain access to this guide.

Reliability and a long service life are synonymous with the Formech brand. However, as with any machinery, certain parts will require periodic replacement.

Seals

The silicon seals applied to the mould table and to the top aperture of the machine (clamp) are seen as being consumable parts, their service life will depend on how the machine is treated and how often it is used.

The table and clamp seals are not covered by our warranty.

Heating elements

The Quartz infrared heating elements supplied with this machine are manufactured using quartz tube and therefore may break or crack with impact or physical shock.

The Quartz heating elements contain internal filaments, which become extremely hot when power is applied. The wire expands and contracts as it heats and cools.

Eventually, due to the continual expansion and contraction, the wire will fracture and a new element will be needed. This may take 10 years or more. Because of this we are unable to apply our standard warranty to Quartz heating elements. However our experience is that this form of infrared heating is durable, reliable and more resilient to shock and impact than similar ceramic products

The heating elements are not covered by our warranty.

Vacuum system

The vacuum system on this machine is fairly simple but uses high quality components throughout. The life expectancy of the vacuum system will be compromised by the ingress of dirt, shavings, dust, liquid etc.



THE VACUUM CIRCUIT INCLUDING THE VACUUM PUMP WILL NOT BE COVERED BY OUR WARRANTY IF THEY ARE FOUND TO BE BLOCKED WITH FOREIGN MATTER OR CORRODED BY THE INGRESS OF LIQUID.

Replacing seals

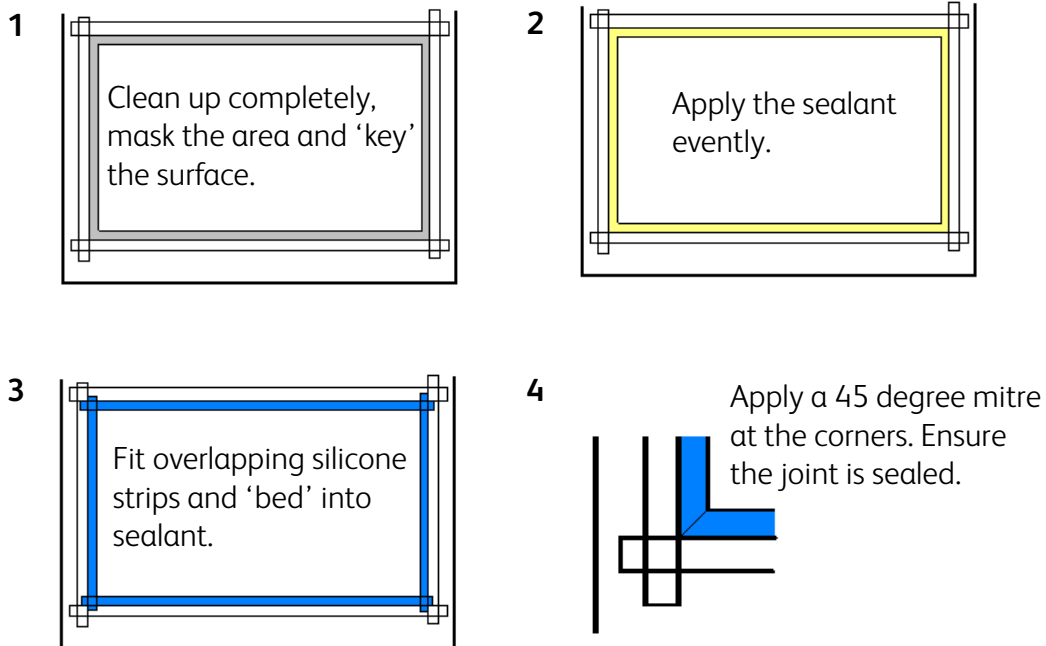

1. Remove all the existing seal and adhesive with a sharp blade. Mask off the sealing area with masking tape or similar (Mask the outside for top frames or reducing windows & the inside for table seals). Prepare the sealing area with emery cloth or similar to achieve a good surface for the new adhesive to key with. Ensure that the surface is clean from dust, dirt and grease.

2. Apply a generous bead of high modulus silicone sealant to the masked area and smooth down to give a consistent layer.

3. Cut the silicone strip in lengths long enough to overlap the corners. Do not stretch the seal strip when measuring or applying. Lay each strip on to the seal area overlapping at the corners. Ensure the seal strip is bedded down well by pressing firmly along the full length.

4. With a sharp blade cut a 45° mitre joint at all corners. Fill gaps in the joints with sealant. Remove the masking tape before the sealant has set. For best performance leave seal to set overnight.

Replacing a heating element

Before any maintenance work is carried out both electrical and air supplies must be locked in the OFF position. Only a qualified electrical technician may work on any parts carrying mains voltage. That person is responsible for ensuring that the machine is in a safe condition before allowing services to be restored.

How to check a heating element

If you notice there is a cold area on heated plastics, it may be that a heating zone or heating element is not working correctly. In either case the first step is to check the wiring at the terminal block. It is not always obvious that they are loose or disconnected.

- 1-** First, check that the heating zones are set correctly, set all the zones to 70% and check for even heat and softening plastic when the heater is held over the forming area with plastic sheet fitted. Make a note of areas where the plastic remains hard to determine if it is a single element of entire zone.
- 2-** If an entire zone is not functioning then remove the top cover and check that the wiring is not loose or has become disconnected for that particular zone. You will have to remove relevant terminal block covers to determine this. If all appears OK then set the defective zone to 100% and check the voltage at the zone using a suitable volt meter.
- 3-** If no voltage is present then contact Formech for service and advice.

If a single element is found to be faulty then it will require replacement. Follow below:

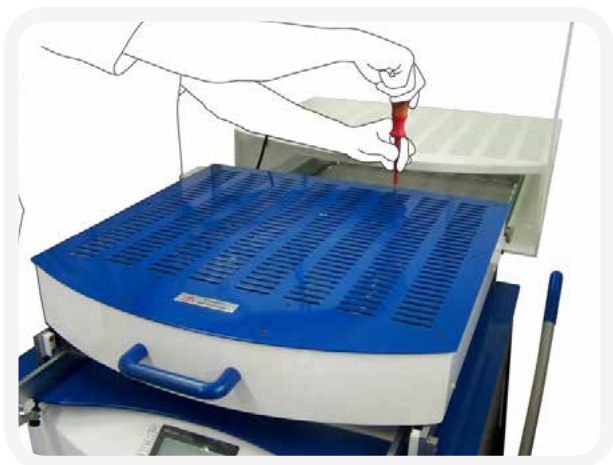

Unplug the machine from the mains. Bring the heater completely forward and remove the 10 screws retaining the cover on top of the heater.

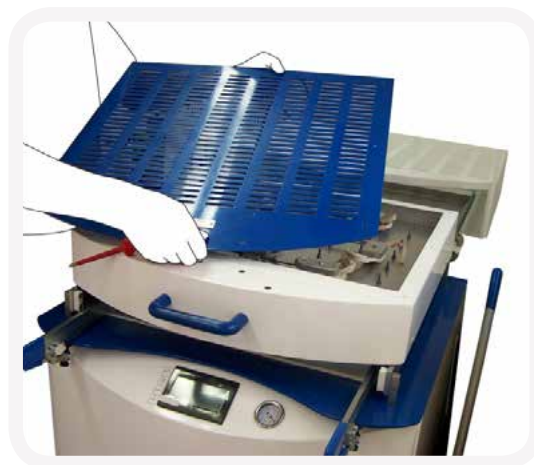

The front 2 screws are retained with an internal plate that will fall when the screws are removed. Retain this plate for fitting during reassembly.

Replacing a heating element (continuation)

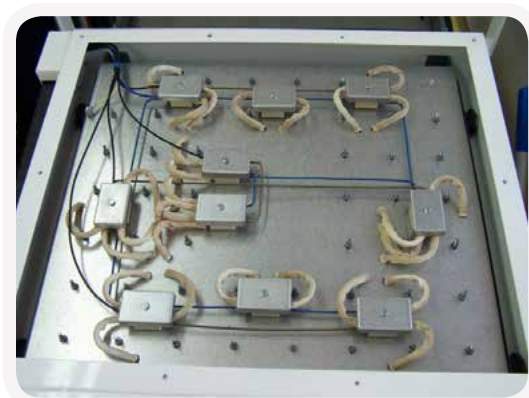

At this stage check that all the element wires and interconnecting wires are fully tightened and that the fault was not merely a loose connection.

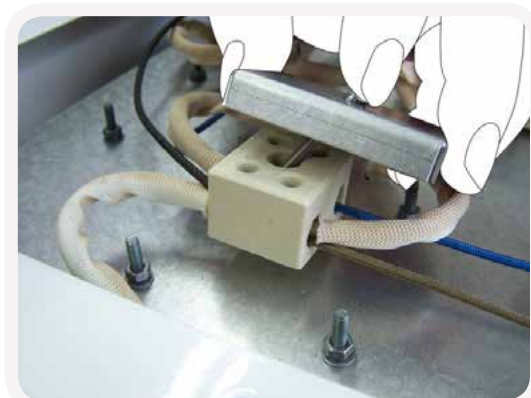

Remove the relevant terminal block cover(s).



Loosen and remove the element wires from the appropriate connector block.



Remove the nuts and washers holding the faulty element.

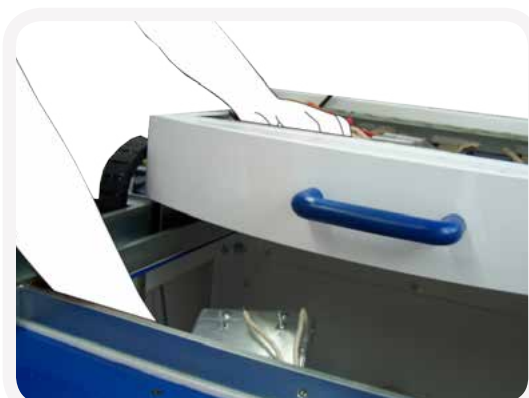

Remove element and fit the replacement new heating element ensuring the fixing screws are secured.

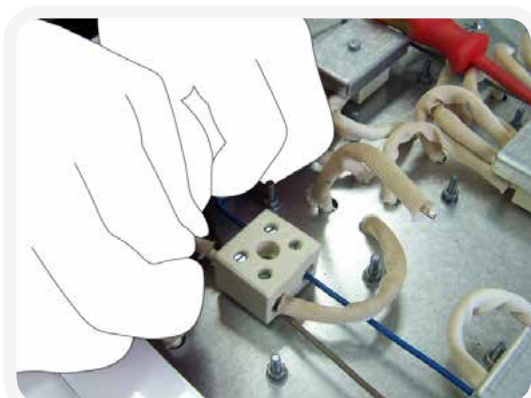

Ensure that the connections are correctly fitted and the connector block screws are fully tightened. Replace the connector cover and test the heater. Finally reassemble the heater top cover and retaining plate for the front fixings.

Electrical Troubleshooting



Before any maintenance work is carried out both electrical and air supplies must be locked in the OFF position or the mains lead removed (508DT).

Only a qualified electrical technician may work on any parts carrying mains voltage and should be responsible for ensuring that the machine is in a safe condition before allowing services to be restored.

Faults on electrical & electronic modules are rare but loose plugs and terminals are responsible for most electrically based failures. A logical approach to detecting the fault begins with a complete appraisal of the faults and symptoms.

Much time can be wasted looking in the wrong areas for a problem that, when found, was obvious. See also section dealing with Electrical circuit information.

A- Checking the back of the machine

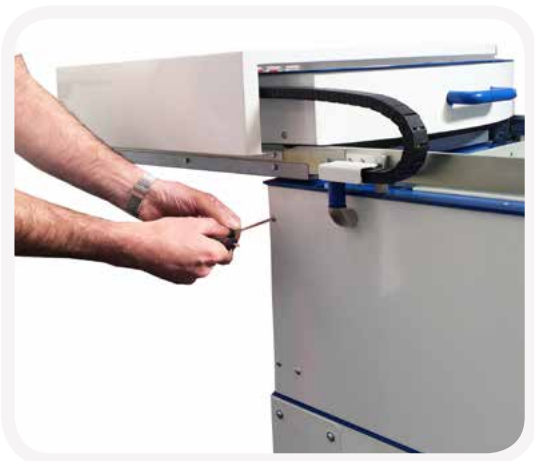

Remove the 7 self-tapping screws retaining the rear panel.



Check all the connections to the inlet receptacle, the fuse holder and the power switch located in the inside back of the machine. The fuse is 20MM, 12.5A .

Electrical Troubleshooting (continuation)

B- Checking the front of the machine



Remove the 4 cap head screws with an allen key 3mm.



Remove the front panel and check the pump switch connections.

If the vacuum pump motor does not run, check the electrical supply. If the motor smells strongly of burnt lacquer then it is probably burnt out and the entire pump/motor assembly needs replacing. If all the connections are good then the switches can be checked for continuity.

Note: Continuity should be obtained between the top and bottom contacts of the switch not side to side.

If the supply is present but the motor hums and does not run, the capacitor may be faulty or has become disconnected. Check the connections to the capacitor by carefully removing its black cover.

Vacuum / Pressure Troubleshooting (508DT & 508FS)

If the vacuum appears to be weak or non-existent check the following:



Raise table in the up position.



Turn the vacuum on.



Place your finger over the vacuum hole and check the reading you get on the vacuu gauge.



If the vacuum gauge reading of 22”Hg or higher is normal. A lower reading indicated poor vacuum where attention is required.

The possible causes of poor vacuum are:

- The mould baseboard is restricting the vacuum hole in the table.
- NOTE: If the mould baseboard is too soft it may pull down under vacuum and block the vacuum hole.
- The mould is inadequately vented to allow trapped air to be evacuated.
- The table and clamp seals are in poor condition or the table is not locking properly at the top of its travel.
- There are holes drilled in the table.

If all the above points are OK and you can hear the pump running when you switch it on then one of the following points will be the cause of the problem. If the pump does not run, refer to the Electrical trouble shooting section above.

- A pipe is loose, damaged or blocked.
- The pump filter is blocked.
- The vacuum valve is blocked.
- The vacuum pump is blocked or corroded.

Vacuum / Pressure Troubleshooting (Continuation)

If the heater has been left in the forward position, with no plastic in the clamp frame, the table will start to overheat. The pipe attached to the back of the table will shrink and constrict the passage of air. Pipes become less flexible over time and may loosen or crack.

Cleaning

Ensure the inside of the machine and the heater tray is cleared of dust, dirt and debris. Do not allow dirt and loose particles to build up, particularly on the heater tray.

Lubrication

The 508DT & 508FS require minimum lubrication.

Apply general purpose grease to the table guide bars when required to assist with table movement.

Apply a small amount of fine silicone oil or fine oil to the heater slide bars when required to assist free movement of the heater.

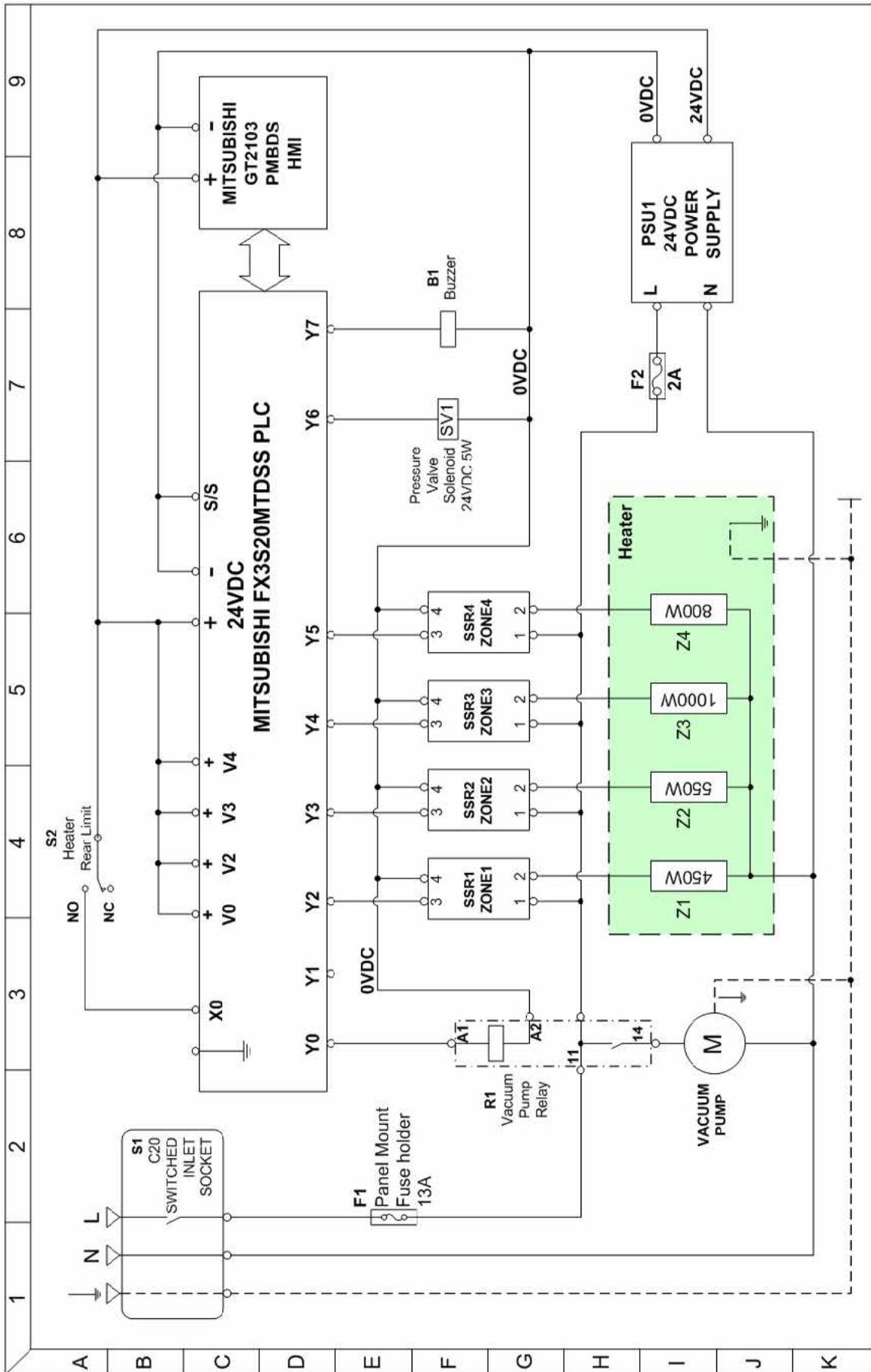

Formech International Ltd	508 DESKTOP			Date:	May 2015	Spec:	208-240V	Name:	508DT Schematic	Page	1
				Model:	508DT	Drawn:	AB				
			Rev:	2	SN	From 2456					



Features

- > Oil free with stainless steel valves
- > Good quality, low noise
- > Easily changed from pressure to vacuum and vice versa
- > Accessory regulating valve and gauge available
- > All models 240V single phase

Specifications

Model	Typical Applications	Typical Performance	Max Pressure
2D351VM	Vacuum filtration	ult. vacuum 51mm Hg	30l/min at 30psi

Typical arrangement

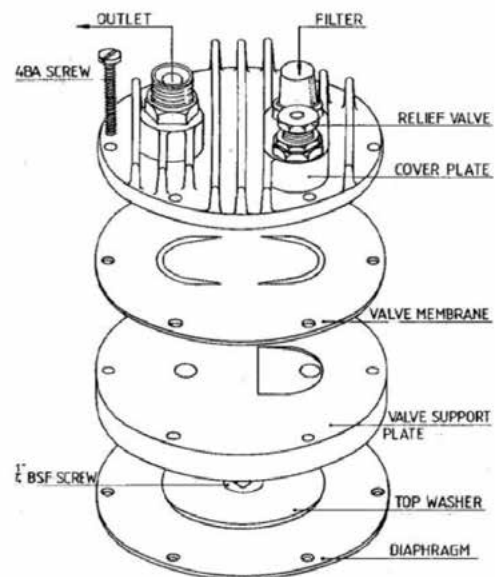
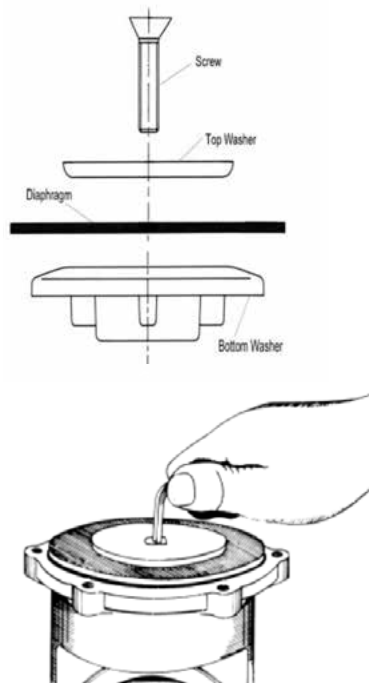
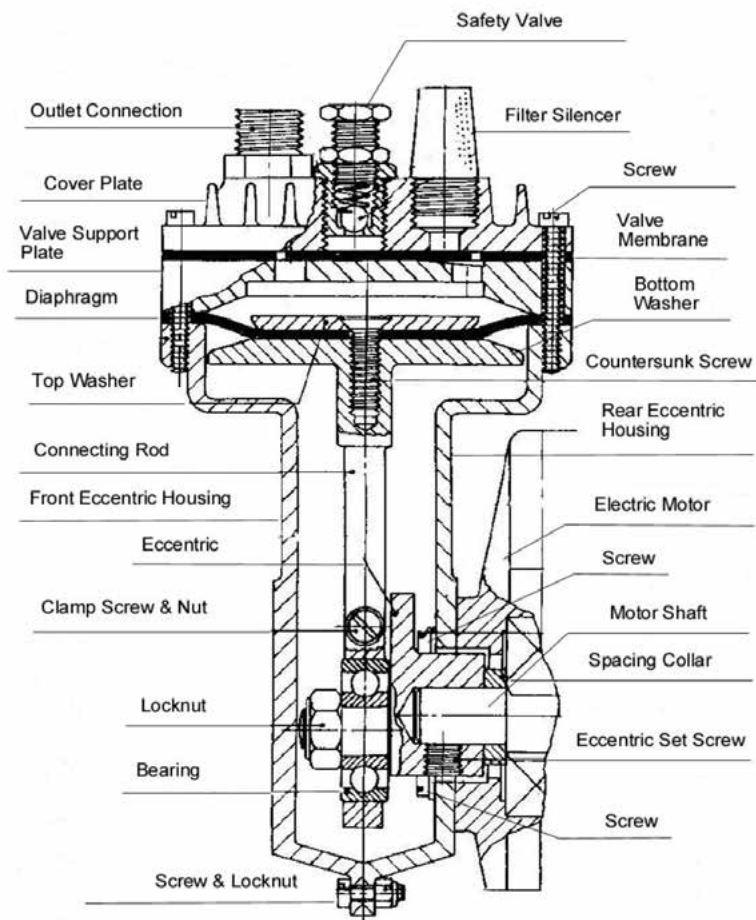

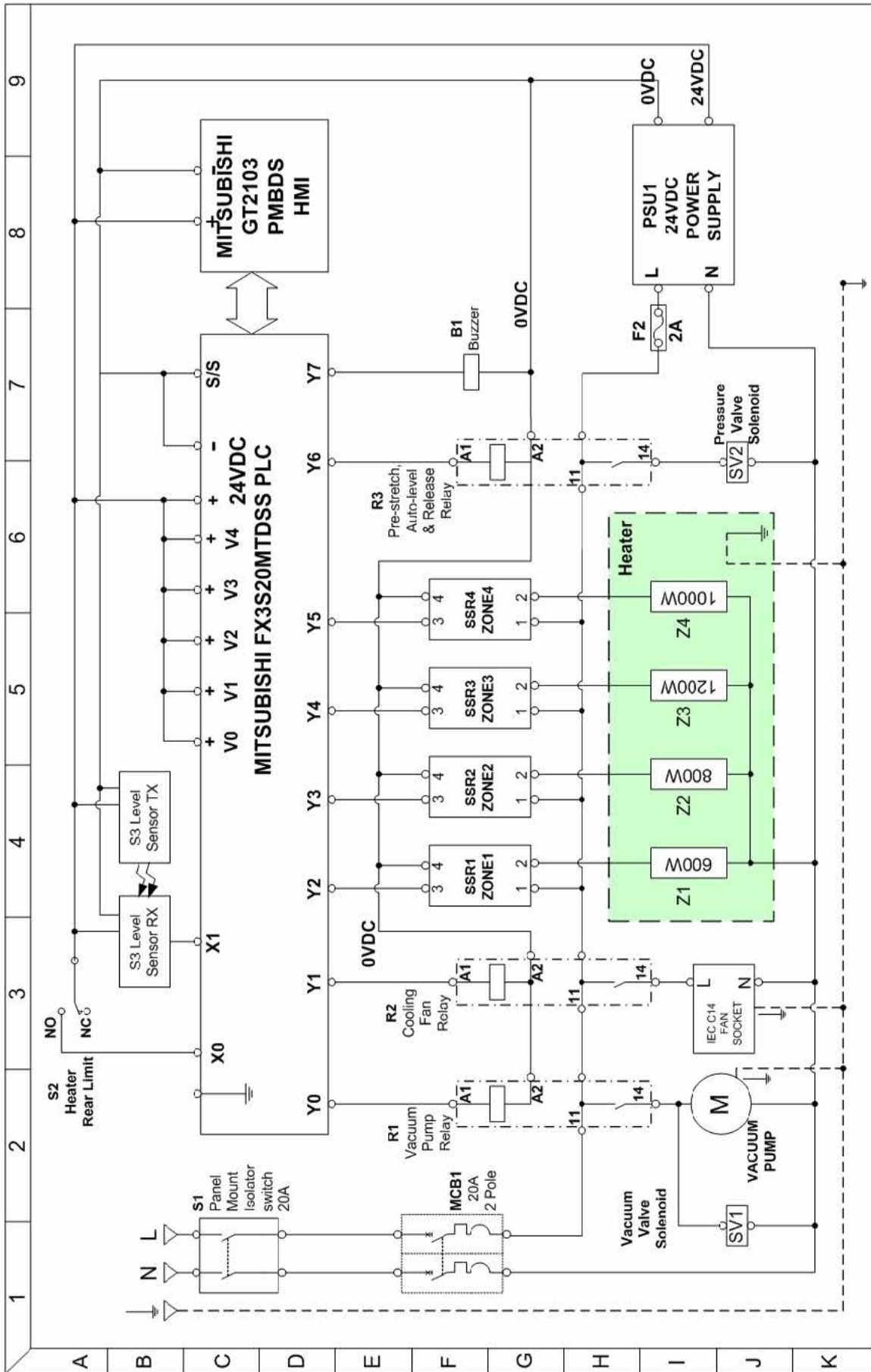

Formech International Ltd	508 FLOORSTANDING			Date:	May 2015	Spec:	208-240V	Name:	508FS Schematic	Page	1
				Model:	508FS	Drawn:	AB				
			Rev:	2	SN	From 5573					



SERVICE

BECKER
D-42279 Wuppertal
www.becker-international.com

year: [] [] [] []

No. (-) [] [] [] [] [] [] [] [] [] [] **Index**

type: **VT 4.10-XX** **Variante**

frequency: [] [] [] [] Hz

speed: [] [] [] [] min⁻¹

power required: [] [] [] [] kW

inlet capacity: [] [] [] [] m³/h

pressure: [] [] [] [] mbar

vacuum: [] [] [] [] mbar

Made in Germany



Spare parts list VT 4.10

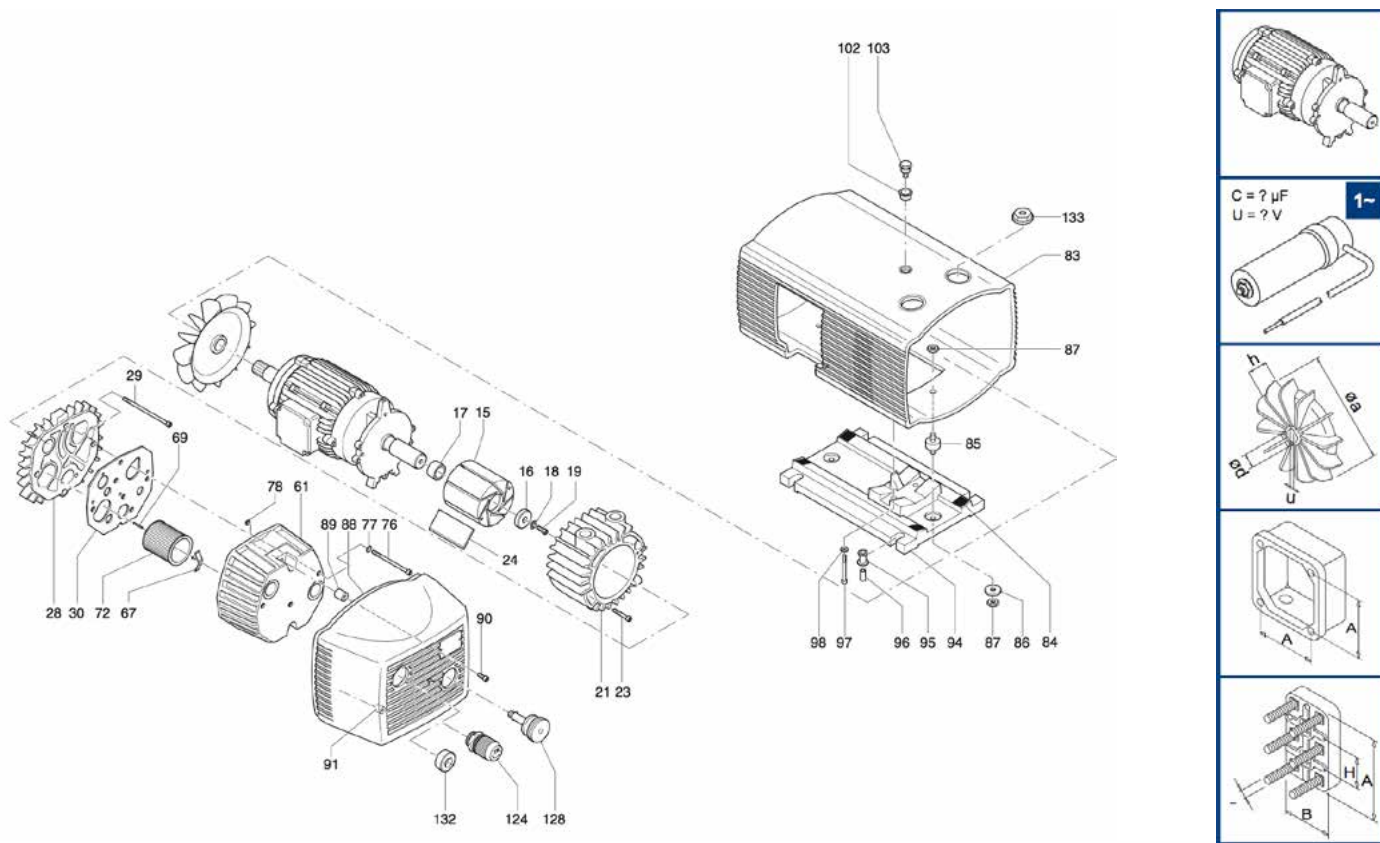

Spare parts list VT 4.10 (continuation)

Position	Identification No.	Description
15	020000 16200	ROTOR
16	016800 05000	CLAMPING DISC
17	911001 00000	STAR-TOLERANCE-RING
18	949203 00000	TOOTHED SPRING WASHER
19	945320 00000	SOCKET HEAD SCREW
21	000100 16200	PUMP BODY
23	945319 00000	SOCKET HEAD SCREW
24	901327 00007	CARBON VANES (KIT)
28	000700 16200	LID
29	945364 00000	SOCKET HEAD SCREW
30	008901 16200	GASKET
61	004800 27300	FILTER COVER
67	009000 16300	BLADE SPRING
69	952009 00000	LOCATING PIN
72	909518 00000	FILTER CARTRIDGE (1x - necessary quantity)
76	945364 00000	SOCKET HEAD SCREW
77	948021 00000	SEALING RING
78	913161 00000	O-RING
83	006800 27300	PROTECTING HOOD
84	060901 16300	ELASTIC PAD
85	741310 50000	RUBBER BUFFER
86	949402 00000	WASHER
87	947001 00000	HEX.NUT
88	006801 27300	PROTECTING HOOD (FRONT)
89	741310 90000	RUBBER BUFFER
90	945318 00000	SOCKET HEAD SCREW
91	951922 00000	RUBBER ELEMENT
94	015100 27300	FOOT
95	951921 00000	RUBBER ELEMENT
96	068000 27600	SPACING COLLAR
97	945363 00000	SOCKET HEAD SCREW
98	949451 00000	WASHER
102	968104 00000	RUBBER SLEEVE
103	029600 16300	BOLT
124	736001 99613	VACUUM REGULATING VALVE
128	727502 06000	BLOW-OFF VALVE
132	951232 00000	SCREW PLUG
133	951224 00000	SCREW PLUG

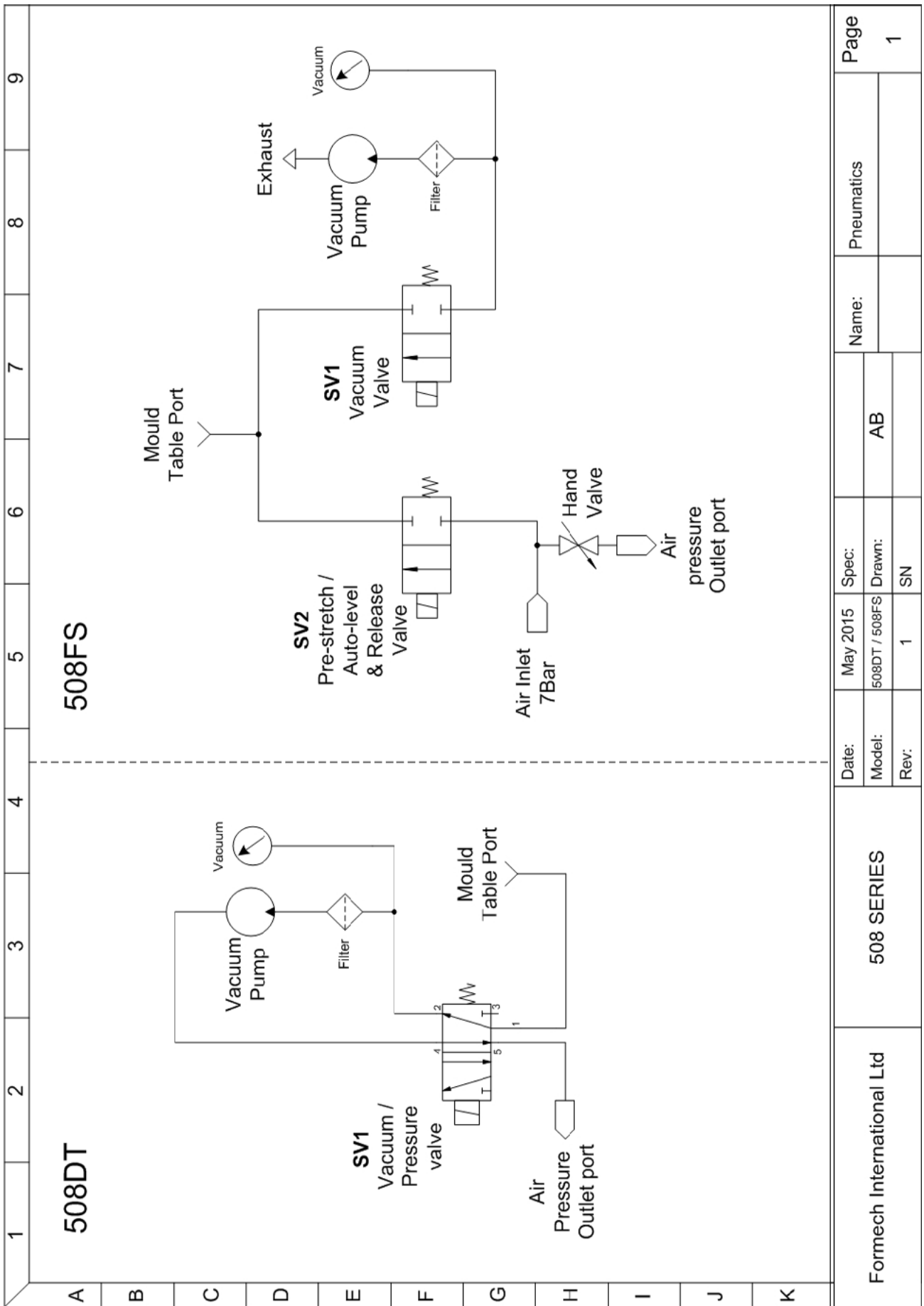

Qty	Description	Part No
3	Quartz Heating Element, 150W FSQ, Zone 1, (508DT)	HEQ02
6	Quartz Heating Element, 200W SQE, Zone 2,3, (508DT)	HEQ11
4	Quartz heating Element, 250W SQE, Zone 4, (508DT)	HEQ12
2	Quartz Heating Element, 125W HSQ, Zone 2, (508DT)	HEQ08
3	Quartz Heating Element, 200W FSQ, Zone 1, (508FS)	HEQ03
6	Quartz Heating Element, 250W SQE, Zone 2,3, (508FS)	HEQ12
4	Quartz heating Element, 300W SQE, Zone 4, (508FS)	HEQ13
2	Quartz Heating Element, 150W HSQ, Zone 2, (508FS)	HEQ09
1	Heatproof Cable 1.63mm Dia (solid)	EE39
1	Heatproof Cable 1.0mm SiFGL	EE40
1	Heatproof Cable 1.5mm SiFGL	EE41
1	Glassfibre Sleeving V111	EE38
10	Ceramic Terminal Block	MPP14
1	Cable chain	EE76
1	Cable chain end Bracket set	EE77
4	Wheel bearing	GH43
1	Large Blue Heater Handle	GH02
1	Limit Switch	EE34
1	C20 Panel Mount Socket & Switch (508DT)	EE49
1	Panel Mount Fuse holder, 25mm (508DT)	EE50
1	25mm 13A Ceramic Fuse (508DT)	EE51
1	2 pole switch panel mount (508FS)	EE85
2	20A MCB, 2 POLE, (508FS)	EE99 20A 2P
1	BS1363/A 3Pin Plug to C19 Power Lead, 13A	EE57
1	EU(Shuko) Plug to C19 Power Lead, 16A	EE56
1	NEMA6/15(N America) Plug to C19 Power Lead, 15A	EE74
1	Buzzer 12-24VDC	EE96
1	PLC FX1S-14	EE03
1	HMI - Touch Screen GT 1020	EE02
1	exp module 2	EE101
1	Communicatons Cable, 1M	EE04
1	24VDC Power Supply, 1A	EE01
1	Relay, single pole, 6A, 24VDC	EE92
1	Triac Htr Output PCB, 4 Channel	EE07
1	Beam Sensor (508FS)	MPP31
1	Vacuum Pump (508DT)	PAP02
1	Large Inline Vacuum Filter (508DT)	PAP05
1	Vacuum Pump & filter unit, VT4.10 (508FS)	PAP06

Qty	Description	Part No
1	Vacuum filter Cartridge (508FS)	PAP15
1	5/2 Valve 24Vdc 6W	P30
1	2/2 Air Valve 1/2"	P05
1	2/2 Vac Valve 1/2"	P06
1	40mm Vacuum Panel Mount Gauge	P31
1	1/4" Bore PVC Reinforced Hose (508DT)	P13
1	3/8" Bore PVC Reinforced Hose	P14
2	1/4" BSPT to 10mm Hose Tail Elbow (508DT)	P34
1	1/4" BSPT to 10mm Hose Tail Straight (508DT)	P36
2	Pipe Clip - Small plastic, Type C, 1/4" Tube (508DT)	P18
6	Pipe Clip - Small plastic, Type F, 3/8" Tube	P37
2	Toggle Clamp Complete, Small Blue (508DT)	MPP19
2	Small Clamp Upper Adjuster Nut Steel M5 (508DT)	MPP27
2	Small Clamp Lower Adjuster Nut Plastic M5 (508DT)	MPP24
2	Toggle Clamp (508FS)	MPP20
2	Toggle Clamp Lower Nut Adjuster M6 Black (508FS)	MPP25
2	Toggle Clamp Upper Nut Adjuster M6 (508FS)	MPP28
2	Clamp Frame Grip	GH44
1	Crank Handle Grip	GH24
1	5M Seal kit, 5M Top Seal, 3m Table Seal, Sealant (Seal kit A)	SK02
1	10M Seal kit, 10M Top Seal, 3m Table Seal, Sealant (Seal kit B)	SK03
1	6mm x 12mm natural rubber Panel seal	MPP12
1	Interlock Spring	GH40
4	Machine Rubber Mounting Foot	GH41
1	Mesh	MPP46

E C Machinery Directive
2006/42/EC

Declaration of conformity

We hereby certify that the machinery stipulated below complies with all the relevant provisions of the EC Machinery Directive and the National Laws and regulations adopting this Directive. Modifications to this machinery without prior approval from the undersigned will render this declaration null and void.

Machine Description: Vacuum Forming Machine
Machine Function: Thermoforming of Plastic Sheet
Model / Type: 508DT/FS
Serial Number:
Date of Manufacture:

Is in conformity with the provisions of the following other EC Directives:

2004 / 108/EC – EMC
 2006 / 95/EC – LVD

Technical File Compiled by: A. Berry at address below.

Formech International Limited, Unit 4, Thrales End Farm, Thrales End Lane, Harpenden
 Hertfordshire AL5 3NS, United Kingdom

Significant harmonised standards applied:

EN ISO 12100 : 2010
 EN ISO13849-1:2006
 EN 60204 –1 : 2006
 EN 12409: 2008

Signed 

Date:
 Name: Paul Vukovich
 Position: Managing Director
 Being the responsible person appointed by the manufacturer

For Parts, Service & Technical Assistance UK,
Europe and Rest of the World
Telephone: +44 (0) 1582 469 797
Fax: +44 (0) 1582 469 646
spares@formech.com

For Parts, Service & Technical Assistance North
and South America
Telephone: 608.424.2524
spares@formechinc.com